

# JVC



## CD RECEIVER

## KD-AR400/KD-G400

ENGLISH

## RECEPTOR CON CD

## KD-AR400/KD-G400

ESPAÑOL

## RECEPTEUR CD

## KD-AR400/KD-G400

Français



CD-RW

MP3

SIRIUS  
COMPATIBLE

COMPACT  
disc  
DIGITAL AUDIO  
TEXT

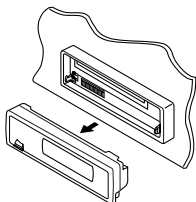

KD-AR400

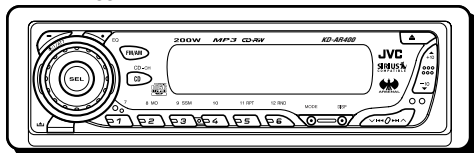

KD-G400

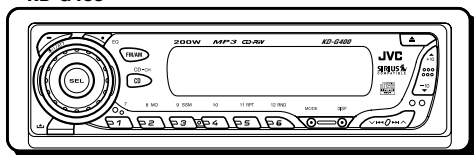

- This unit is equipped with the display demonstration. To cancel it, see page 8.
- Esta unidad está equipada con demostración en la pantalla. Para cancelarla, consulte la página 8.
- Cet appareil est équipé d'une fonction de démonstration des affichages. Pour l'annuler, référez-vous à la page 8.

For installation and connections, refer to the separate manual.

Para la instalación y las conexiones, refiérase al manual separado.

Pour l'installation et les raccordements, se référer au manuel séparé.

# INSTRUCTIONS

MANUAL DE INSTRUCCIONES  
MANUEL D'INSTRUCTIONS

### For customer Use:

Enter below the Model No. and Serial No. which are located on the top or bottom of the cabinet. Retain this information for future reference.

Model No. \_\_\_\_\_

Serial No. \_\_\_\_\_

GET0189-001A

[J]

**INFORMATION (For U.S.A.)**

This equipment has been tested and found to comply with the limits for a Class B digital device, pursuant to Part 15 of the FCC Rules. These limits are designed to provide reasonable protection against harmful interference in a residential installation. This equipment generates, uses, and can radiate radio frequency energy and, if not installed and used in accordance with the instructions, may cause harmful interference to radio communications. However, there is no guarantee that interference will not occur in a particular installation. If this equipment does cause harmful interference to radio or television reception, which can be determined by turning the equipment off and on, the user is encouraged to try to correct the interference by one or more of the following measures:

- Reorient or relocate the receiving antenna.
- Increase the separation between the equipment and receiver.
- Connect the equipment into an outlet on a circuit different from that to which the receiver is connected.
- Consult the dealer or an experienced radio/TV technician for help.

**IMPORTANT FOR LASER PRODUCTS**

1. CLASS 1 LASER PRODUCT
2. **CAUTION:** Do not open the top cover. There are no user serviceable parts inside the unit; leave all servicing to qualified service personnel.
3. **CAUTION:** Visible and invisible laser radiation when open and interlock failed or defeated. Avoid direct exposure to beam.

**How to reset your unit**

After detaching the control panel, press the reset button on the panel holder using a ball-point pen or a similar tool. This will reset the built-in microcomputer.

**Note:**

*Your preset adjustments—such as preset channels or sound adjustments—will also be erased.*

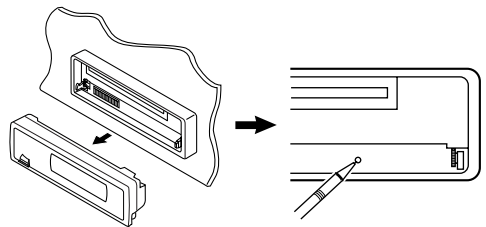
**BEFORE USE****\*For safety...**

- Do not raise the volume level too much, as this will block outside sounds, making driving dangerous.
- Stop the car before performing any complicated operations.

**\*Temperature inside the car...**

*If you have parked the car for a long time in hot or cold weather, wait until the temperature in the car becomes normal before operating the unit.*

Thank you for purchasing a JVC product. Please read all instructions carefully before operation, to ensure your complete understanding and to obtain the best possible performance from the unit.

# CONTENTS

How to reset your unit .....	2	<b>MP3 OPERATIONS</b> .....	<b>18</b>
How to use the MODE button .....	3	Playing an MP3 disc .....	18
<b>LOCATION OF THE BUTTONS</b> .....	<b>4</b>	Locating a file or a particular portion on an MP3 disc .....	19
Control panel .....	4	Selecting MP3 playback modes .....	21
Remote controller .....	5	<b>SOUND ADJUSTMENTS</b> .....	<b>22</b>
Preparing the remote controller .....	6	Selecting preset sound modes (C-EQ: custom equalizer) .....	22
<b>BASIC OPERATIONS</b> .....	<b>7</b>	Adjusting the sound .....	23
Turning on the power .....	7	<b>OTHER MAIN FUNCTIONS</b> .....	<b>24</b>
Canceling the display demonstration .....	8	Changing the general settings (PSM) .....	24
Setting the clock .....	9	Detaching the control panel .....	27
<b>RADIO OPERATIONS</b> .....	<b>10</b>	<b>CD CHANGER OPERATIONS</b> .....	<b>28</b>
Listening to the radio .....	10	Playing discs .....	28
Storing stations in memory .....	11	Selecting the playback modes .....	31
Tuning in to a preset station .....	12	<b>EXTERNAL COMPONENT OPERATIONS</b> ...	<b>32</b>
<b>CD OPERATIONS</b> .....	<b>13</b>	Playing an external component .....	32
Playing a CD .....	13	<b>TROUBLESHOOTING</b> .....	<b>33</b>
Locating a track or a particular portion on a CD .....	14	<b>MAINTENANCE</b> .....	<b>36</b>
Selecting CD playback modes .....	15	Handling discs .....	36
Playing a CD Text .....	16	<b>SPECIFICATIONS</b> .....	<b>37</b>
Prohibiting disc ejection .....	16		
<b>MP3 INTRODUCTION</b> .....	<b>17</b>		
What is MP3? .....	17		
How are MP3 files recorded and played back? .....	17		

## How to use the MODE button

If you press MODE, the unit goes into functions mode, then the number buttons and ▲/▼ buttons work as different function buttons.

Ex.: When number button 2 works as MO (monaural) button.

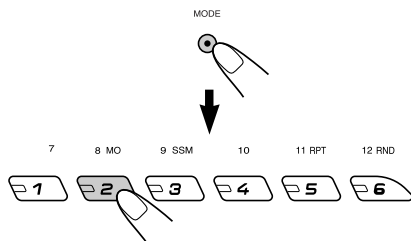

Time countdown indicator

To use these buttons for original functions again after pressing MODE, wait for 5 seconds without pressing any of these buttons until the functions mode is cleared.

- Pressing MODE again also clears the functions mode.



# LOCATION OF THE BUTTONS

## Control panel

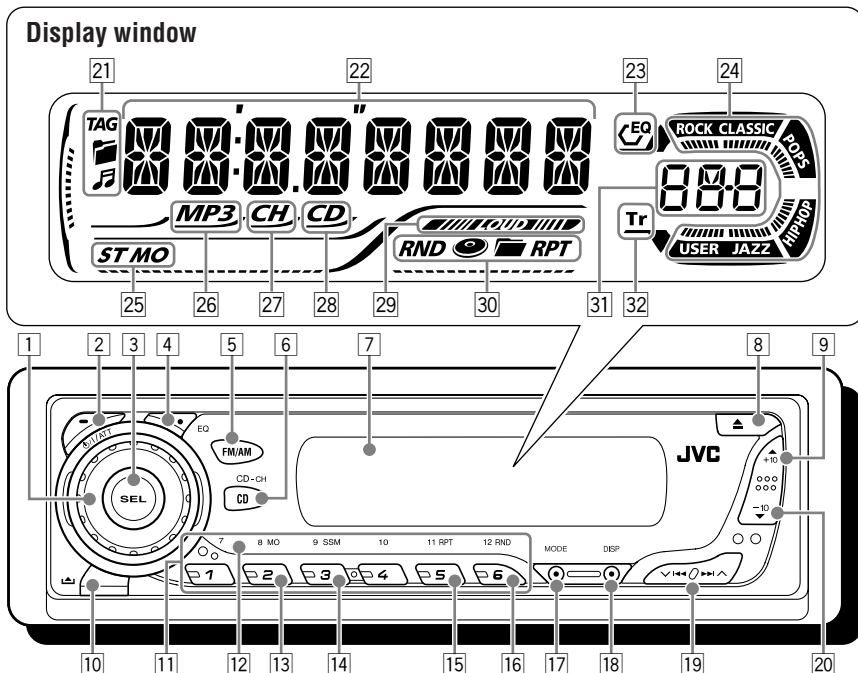

- 1 Control dial
- 2  $\Phi$ /I/ATT (standby/on/attenuator) button
- 3 SEL (select) button
- 4 EQ (equalizer) button
- 5 FM/AM button
- 6 CD CD-CH (CD changer) button
- 7 Display window
- 8  $\blacktriangle$  (eject) button
- 9  $\blacktriangle$  (up) button  
+10 button
- 10  $\blacktriangle$  (control panel release) button
- 11 Number buttons
- 12 Remote sensor
- 13 MO (monaural) button
- 14 SSM (Strong-station Sequential Memory) button
- 15 RPT (repeat) button
- 16 RND (random) button
- 17 MODE button
- 18 DISP (display) button
- 19  $\blacktriangledown$   $\blacktriangleleft$   $\blacktriangleright$   $\blacktriangle$  buttons
- 20  $\blacktriangledown$  (down) button  
-10 button

## Display window

- 21 Disc information indicators  
TAG (ID3 Tag),  $\mathcal{F}$  (folder),  $\mathcal{M}$  (track/file)
- 22 Main display
- 23 EQ (equalizer) indicator
- 24 Sound mode (C-EQ: custom equalizer) indicators  
ROCK, CLASSIC, POPS, HIP HOP, JAZZ, USER  
•  $\text{|||||}$  also works as level meter during play if the level meter is activated (see page 25).
- 25 Tuner reception indicators  
ST (stereo), MO (monaural)
- 26 MP3 indicator
- 27 CH (CD changer) indicator
- 28 CD indicator
- 29 LOUD (loudness) indicator
- 30 Playback item/mode indicators  
RND (random),  $\text{CD}$  (disc),  $\mathcal{F}$  (folder), RPT (repeat)
- 31 Source display  
Volume level indicator
- 32 Tr (track) indicator



# Remote controller

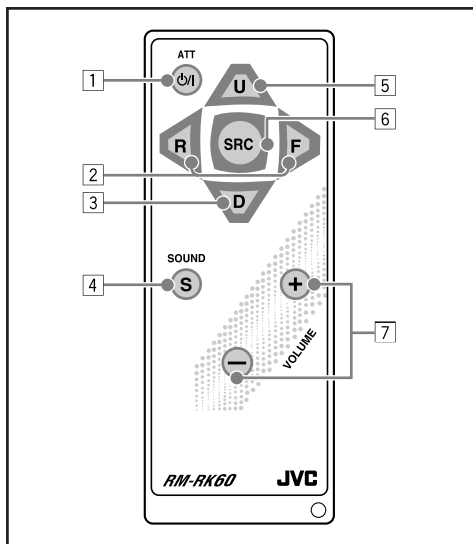

- 1 • Turns on the unit if pressed when the unit is turned off.
- Turns off the unit if pressed and held until “SEE YOU” appears on the display.
- Drops the volume level in a moment if pressed briefly.  
Press again to resume the volume.
- 2 • Searches for stations while listening to the radio.
- Fast-forwards or reverses the track/file if pressed and held while listening to a disc.
- Skips to the beginning of the next track/file or goes back to the beginning of the current (or previous) tracks/files if pressed briefly while listening to a disc.

- 3 • Selects the preset stations while listening to the radio.  
Each time you press the button, the preset station number increases, and the selected station is tuned in.
  - Skips to the first file of the previous folder while listening to an MP3 disc.  
Each time you press the button, you can move to the previous folder and start playing the first file.
  - While playing an MP3 disc on an MP3-compatible CD changer;
    - Skips to the previous disc if pressed briefly.
    - Skips to the previous folder if pressed and held.
- Note:** While playing a CD on a CD changer, this always skips to the previous disc.

- 4 Selects the sound mode (C-EQ: custom equalizer).  
Each time you press the button, the sound mode (C-EQ) changes.
  - 5 • Selects the band while listening to the radio.  
Each time you press the button, the band changes.
  - Skips to the first file of the next folder while listening to an MP3 disc.  
Each time you press the button, you can move to the next folder and start playing the first file.
  - While playing an MP3 disc on an MP3-compatible CD changer;
    - Skips to the next disc if pressed briefly.
    - Skips to the next folder if pressed and held.
- Note:** While playing a CD on a CD changer, this always skips to the next disc.

- 6 Selects the source.  
Each time you press the button, the source changes.
- 7 Functions the same as the control dial on the main unit.  
**Note:** These buttons do not function for the preferred setting mode adjustment.

## Preparing the remote controller

Before using the remote controller:

- Aim the remote controller directly at the remote sensor on the main unit. Make sure there is no obstacle in between.

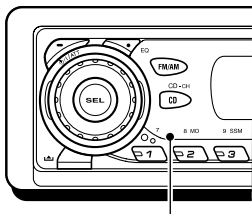

Remote sensor

- Do not expose the remote sensor to strong light (direct sunlight or artificial lighting).

### Installing the battery

When the controllable range or effectiveness of the remote controller decreases, replace the battery.

#### 1. Remove the battery holder.

- 1) Push out the battery holder in the direction indicated by the arrow using a ball-point pen or a similar tool.
- 2) Remove the battery holder.

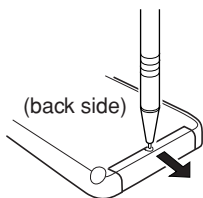

#### 2. Place the battery.

Slide the battery into the holder with the + side facing upwards so that the battery is fixed in the holder.

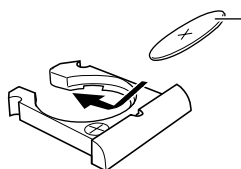

Lithium coin battery (product number: CR2025)

#### 3. Return the battery holder.

Insert again the battery holder by pushing it until you hear a clicking sound.

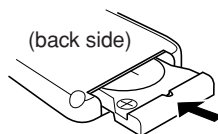

#### WARNING:

- Store the battery in a place where children cannot reach.  
*If a child accidentally swallows the battery, consult a doctor immediately.*
- Do not recharge, short, disassemble, or heat the battery or dispose of it in a fire.  
*Doing any of these things may cause the battery to give off heat, crack, or start a fire.*
- Do not leave the battery with other metallic materials.  
*Doing this may cause the battery to give off heat, crack, or start a fire.*
- When throwing away or saving the battery, wrap it in tape and insulate; otherwise, the battery may start to give off heat, crack, or start a fire.
- Do not poke the battery with tweezers or similar tools.  
*Doing this may cause the battery to give off heat, crack, or start a fire.*

#### CAUTION:

*DO NOT leave the remote controller in a place (such as dashboards) exposed to direct sunlight for a long time. Otherwise, it may be damaged.*

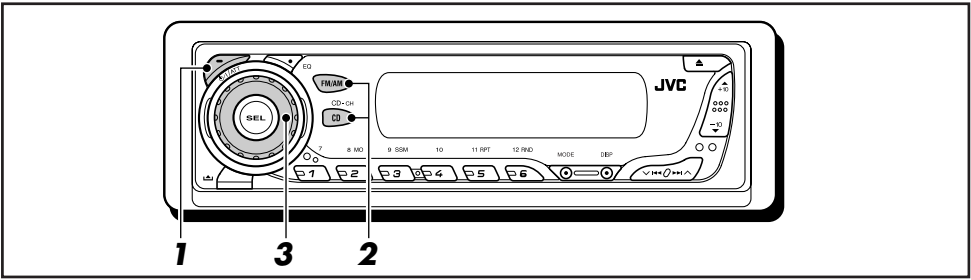

## Turning on the power

### 1 Turn on the power.

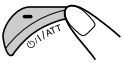

#### Note on One-Touch Operation:

When you select a source in step 2 below, the power automatically comes on. You do not have to press this button to turn on the power.

### 2 Select the source.

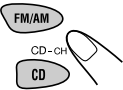

- To operate the tuner (FM or AM), see pages 10 – 12.
- To play a CD, see pages 13 – 16.
- To play an MP3 disc, see pages 18 – 21.
- To operate the CD changer, see pages 28 – 31.
- To operate the external component (LINE IN or SIRIUS), see page 32.

### 3 Adjust the volume.

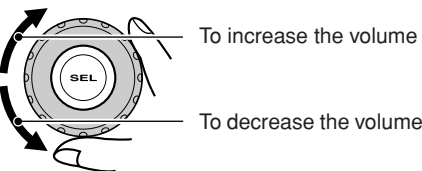

Volume level appears.

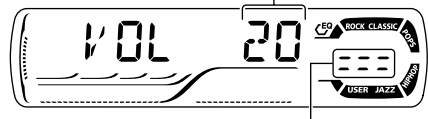

Volume level indicator

### 4 Adjust the sound as you want. (See pages 22 and 23.)

#### To drop the volume in a moment

Press **PWR/ATT** briefly while listening to any source. "ATT" starts flashing on the display, and the volume level will drop in a moment. To resume the previous volume level, press the button briefly again.

- If you turn the control dial, you can also restore the sound.

#### To turn off the power

Press and hold **PWR/ATT** for more than one second.

"SEE YOU" appears, then the unit turns off.

- **If you turn off the power while listening to a disc**, disc play will start from where playback has been stopped previously, next time you turn on the power.

#### CAUTION on Volume Setting:

Discs produce very little noise compared with other sources. If the volume level is adjusted for the tuner, for example, the speakers may be damaged by the sudden increase in the output level. Therefore, lower the volume before playing a disc and adjust it as required during playback.

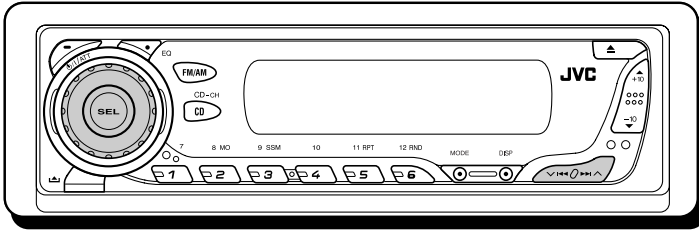

## Canceling the display demonstration

When shipped from the factory, display demonstration has been activated, and starts automatically when no operations are done for about 20 seconds.

- It is recommended to cancel the display demonstration before you use the unit for the first time.

To cancel the display demonstration, follow the procedure below:

- 1** Press and hold SEL (select) for more than 2 seconds so that one of the PSM items appears on the display. (PSM: see page 25.)



- 2** Select "DEMO" if not shown on the display.



- 3** Select "DEMO OFF."

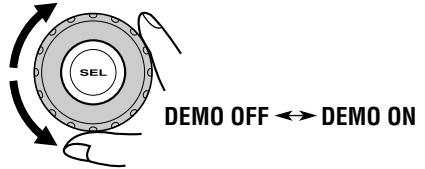

- 4** Finish the setting.



To activate the display demonstration, repeat the same procedure and select "DEMO ON" in step 3.



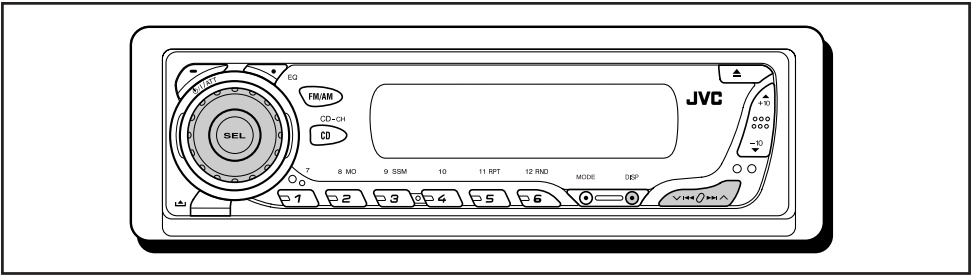

## Setting the clock

**1** Press and hold SEL (select) for more than 2 seconds so that one of the PSM items appears on the display. (PSM: see page 25.)



**2** Set the hour.

- 1 Select "CLOCK H" (hour) if not shown on the display.
- 2 Adjust the hour.

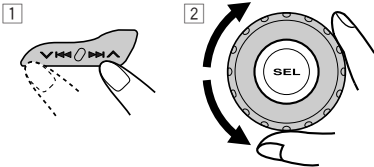

**3** Set the minute.

- 1 Select "CLOCK M" (minute).
- 2 Adjust the minute.

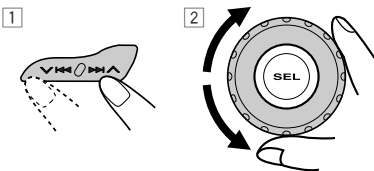

**4** Finish the setting.



To check the current clock time or change the display mode



Press DISP (display) repeatedly. Each time you press the button, the display changes as follows:

• During tuner operation:

Frequency ↔ Clock

• During disc operation:

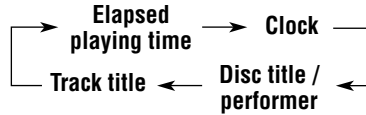

**Notes:**

- While playing a conventional CD, "NO NAME" appears for the disc title/performer and the track title.
- For indication change while playing a CD Text or an MP3 disc, see also pages 16 and 19.

• During external component operation:

LINE IN ↔ Clock

• During SIRIUS operation:

SIRIUS ↔ Clock

• During power off:

The power turns on and the clock time is shown for 5 seconds, then the power turns off.



# RADIO OPERATIONS

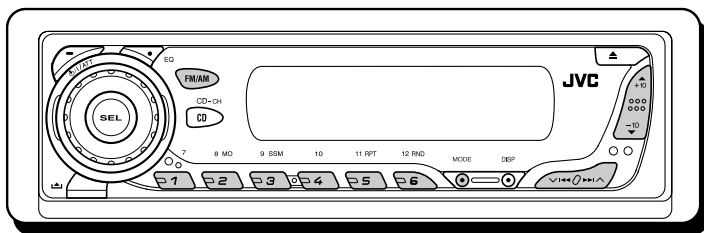

## Listening to the radio

You can use either automatic searching or manual searching to tune in to a particular station.

### Searching for a station automatically: Auto search

#### 1 Select the band (FM1 – 3, AM).



Each time you press the button, the band changes as follows:

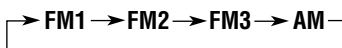

Selected band appears.

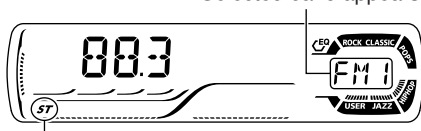

Lights up when receiving an FM stereo broadcast with sufficient signal strength.

#### Note:

This receiver has three FM bands (FM1, FM2, FM3). You can use any one of them to listen to an FM broadcast.

#### 2 Start searching for a station.

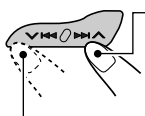

To search stations of higher frequencies

To search stations of lower frequencies

When a station is received, searching stops.

To stop searching before a station is received, press the same button you have pressed for searching.

### Searching for a station manually: Manual search

#### 1 Select the band (FM1 – 3, AM).



Each time you press the button, the band changes as follows:

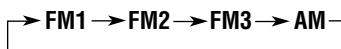

#### Note:

This receiver has three FM bands (FM1, FM2, FM3). You can use any one of them to listen to an FM broadcast.

#### 2 Press and hold ►►► ▲ or ▼ ◀◀◀ until "M" (manual) starts flashing on the display.

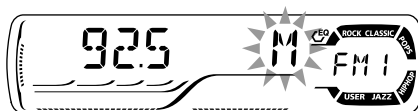

### 3 Tune in to a station you want while “M” (manual) is still flashing.

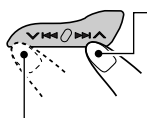

To tune in to stations of higher frequencies

To tune in to stations of lower frequencies

- If you release your finger from the button, the manual mode will automatically turn off after 5 seconds.
- If you hold down the button, the frequency keeps changing (in 200 kHz intervals for FM and 10 kHz for AM) until you release the button.

## Storing stations in memory

You can use one of the following two methods to store broadcasting stations in memory.

- Automatic preset of FM stations: SSM (Strong-station Sequential Memory)
- Manual preset of both FM and AM stations

### FM station automatic preset: SSM

You can preset 6 local FM stations in each FM band (FM1, FM2, and FM3).

#### 1 Select the FM band (FM1 – 3) you want to store FM stations into.



Each time you press the button, the band changes as follows:

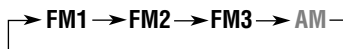

#### 2 Press MODE to enter the functions mode.



#### 3 Press and hold SSM for about 2 seconds.

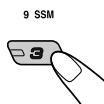

“SSM” flashes, then disappears when automatic preset is over.

Local FM stations with the strongest signals are searched and stored automatically in the band number you have selected (FM1, FM2, or FM3). These stations are preset in the number buttons —No.1 (lowest frequency) to No.6 (highest frequency).

When automatic preset is over, the station stored in number button 1 will be automatically tuned in.

### When an FM stereo broadcast is hard to receive:

MODE



- 1 Press MODE to enter the functions mode while listening to an FM stereo broadcast.

8 MO



- 2 Press MO (monaural), while “MODE” is still flashing on the display, so that “MONO” appears on the display. Each time you press the button, the monaural mode turns on and off alternately.



MO (monaural) indicator

When the MO indicator is lit on the display, the sound you hear becomes monaural but the reception will be improved.



## Manual preset

You can preset up to 6 stations in each band (FM1, FM2, FM3, and AM) manually.

Ex.: Storing FM station of 92.5 MHz into the preset number 1 of the FM1 band.

### 1 Select the band (FM1 – 3, AM) you want to store stations into (in this example, FM1).



Each time you press the button, the band changes as follows:

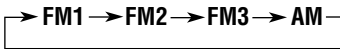

### 2 Tune in to a station (in this example, of 92.5 MHz).

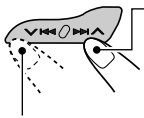

To tune in to stations of higher frequencies

To tune in to stations of lower frequencies



### 3 Press and hold the number button (in this example, 1) for more than 2 seconds.

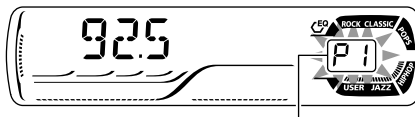
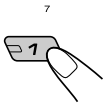

Preset number flashes for a while.

### 4 Repeat the above procedure to store other stations into other preset numbers.

#### Notes:

- A previously preset station is erased when a new station is stored in the same preset number.
- Preset stations are erased when the power supply to the memory circuit is interrupted (for example, during battery replacement). If this occurs, preset the stations again.

## Tuning in to a preset station

You can easily tune in to a preset station. Remember that you must store stations first. If you have not stored them yet, see “Storing stations in memory” on pages 11 and 12.

### 1 Select the band (FM1 – 3, AM).



Each time you press the button, the band changes as follows:

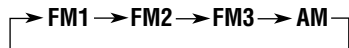

### 2 Select the number (1 – 6) for the preset station you want.

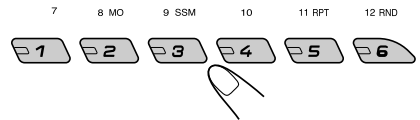

#### Note:

You can also use the ▲ (up) or ▼ (down) button on the unit to select the next or previous preset stations. Each time you press the ▲ (up) or ▼ (down) button, the next or previous preset station is tuned in.

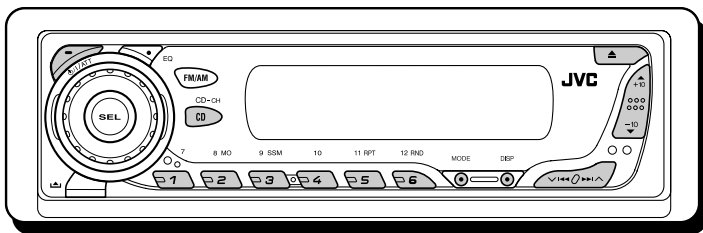

Refer to "MP3 OPERATIONS" on pages 18 to 21 for operating MP3 discs.

The display changes to show the following:

## Playing a CD

### 1 Open the control panel.

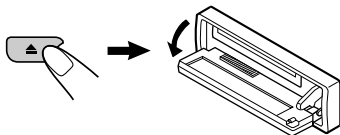

#### Note on One-Touch Operation:

When a CD is already in the loading slot, pressing CD-CH turns on the unit and starts playback automatically.

### 2 Insert a CD into the loading slot.

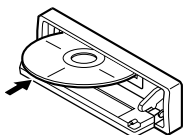

The unit turns on, draws the CD and starts playback automatically.

### 3 Close the control panel by hand.

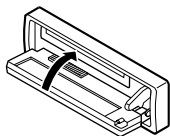

All tracks will be played repeatedly until you stop playback.

Current source indication

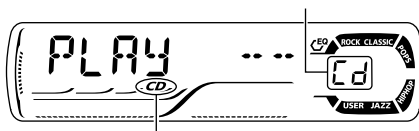

CD indicator

Total playing time of the inserted disc      Total track number of the inserted disc

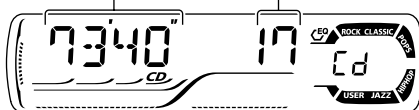

Elapsed playing time      Current track number

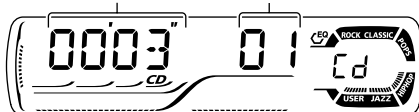

#### Notes:

- When a CD is inserted upside down, the CD automatically ejects (if the control panel is open). If the control panel is closed, the source changes to the previously selected source, "PLEASE" and "EJECT" appear alternately on the display.
- If there is no CD in the loading slot, you cannot select CD as the source. "NO DISC" appears on the display.
- If the current disc is a CD Text, disc title/performer and then track title will automatically appear.



## To stop play and eject the CD

Press ▲.

CD play stops and the control panel flips down. The CD automatically ejects from the loading slot. The source changes to the previously selected source.

- If you change the source, CD play also stops (without ejecting the CD).

Next time you select “CD” as the source, CD play starts from where playback has been stopped previously.

### Notes:

- If the ejected disc is not removed for about 15 seconds, the disc is automatically inserted again into the loading slot to protect it from dust. (Disc play will not start this time.)
- You can eject the disc even when the unit is turned off.

## Locating a track or a particular portion on a CD

### To fast-forward or reverse the track



Press and hold ►►► ▲, while playing a CD, to fast-forward the track.

Press and hold ▼ ◀◀◀, while playing a CD, to reverse the track.

### To go to the next or previous tracks

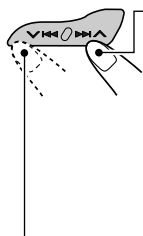

Press ►►► ▲ briefly, while playing a CD, to go ahead to the beginning of the next track.

Each time you press the button consecutively, the beginning of the next tracks is located and played back.

Press ▼ ◀◀◀ briefly, while playing a CD, to go back to the beginning of the current track.

Each time you press the button consecutively, the beginning of the previous tracks is located and played back.

## To go to a particular track directly

Press the number button corresponding to the track number to start its playback.

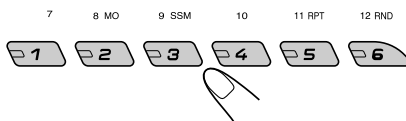

- To select a track number from 1 – 6:  
Press 1 (7) – 6 (12) briefly.
- To select a track number from 7 – 12:  
Press and hold 1 (7) – 6 (12) for more than one second.

## To go to a track quickly (+10 and –10 buttons)

- 1 Press MODE to enter the functions mode while playing a CD.

MODE



- 2 Press +10 or –10.

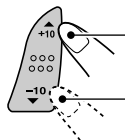

To skip 10 tracks\* forwards to the last track

To skip 10 tracks\* backwards to the first track

- \* First time you press +10 or –10 button, the track skips to the nearest higher or lower track with a track number of multiple ten (ex. 10th, 20th, 30th).

Then each time you press the button, you can skip 10 tracks (see “How to use the +10 and –10 buttons” on page 15).

- After the last track, the first track will be selected, and vice versa.



### How to use the +10 and -10 buttons

• Ex. 1: To select track number 32 while playing track number 6

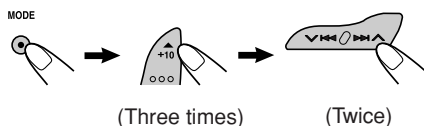

Track 6 → 10 → 20 → 30 → 31 → 32

• Ex. 2: To select track number 8 while playing track number 36

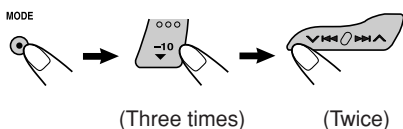

Track 36 → 30 → 20 → 10 → 9 → 8

### To play back tracks repeatedly (Track Repeat Play)

You can play back the current track repeatedly.

MODE



1 Press MODE to enter the functions mode while playing a CD.

11 RPT



2 Press RPT (repeat), while "MODE" is still flashing on the display, so that "TRK RPT" appears on the display. Each time you press the button, track repeat play mode turns on and off alternately.

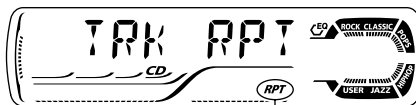

RPT indicator

When track repeat play is turned on, the RPT indicator lights up on the display. The current track starts playing repeatedly.

### Selecting CD playback modes

#### To play back tracks at random (Disc Random Play)

You can play back all tracks on the CD at random.

MODE



1 Press MODE to enter the functions mode while playing a CD.

12 RND



2 Press RND (random), while "MODE" is still flashing on the display, so that "DISC RND" appears on the display. Each time you press the button, disc random play mode turns on and off alternately.

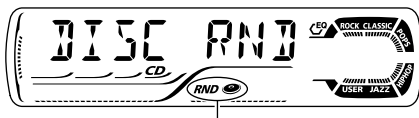

RND and (disc) indicators

When disc random play is turned on, the RND and (disc) indicators light up on the display. A track randomly selected starts playing.



## Playing a CD Text

In a CD Text, some information about the disc (its disc title, performer, and track title) is recorded. This CD Text information will be shown automatically when you play a CD Text.

**To change the CD Text information manually, select text display mode while playing a CD Text.**



Press DISP (display) repeatedly. Each time you press the button, the display changes as follows:

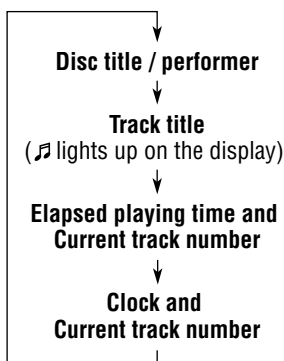

### Notes:

- The display shows up to 8 characters at one time and scrolls if there are more than 8 characters. See also “To select the scroll mode—SCROLL” on page 26. Some characters or symbols will not be shown (and will be blanked) on the display. (Ex. “ABC&!d#” ⇔ “ABCA D ”)
- When you press DISP (display) while playing a conventional CD, “NO NAME” appears for the disc title/performer and the track title.
- When track title is shown, the Tr indicator and current track number also appear on the right side of the display.

## Prohibiting disc ejection

You can prohibit disc ejection and can lock a disc in the loading slot.

**While pressing CD CD-CH, press and hold /ATT for more than 2 seconds.**



“NO EJECT” flashes on the display for about 5 seconds, and the disc is locked and cannot be ejected.



**To cancel the prohibition and unlock the disc**

While pressing CD CD-CH, press and hold /ATT again for more than 2 seconds.

“EJECT OK” flashes on the display for about 5 seconds, and the disc is unlocked.







# MP3 INTRODUCTION

## What is MP3?

MP3 is an abbreviation of Motion Picture Experts Group (or MPEG) Audio Layer 3. MP3 is simply a file format with a data compression ratio of 1:10 (128 Kbps\*).

\* *Bit rate is the average number of bits that one second of audio data will consume. The unit used is Kbps. To get a better audio quality, choose a higher bit rate. The most popular bit rate for encoding is 128 Kbps.*

- For details information about the MP3 discs, refer to “A Guide to MP3/WMA” (separate volume).

## Compatible with ID3 Tag

Extra information data such as album title, performer name, song title, recording year, music genre and a brief comment can be stored within an MP3 file.

This unit can show both ID3v1 (Version 1) and ID3v2 (version 2) tags on the display. (See page 19.)

- Some characters cannot be shown correctly.
- If both ID3v1 and ID3v2 are recorded on a disc, ID3v2 information will be shown.

## How are MP3 files recorded and played back?

MP3 “files (tracks)” can be recorded in “folders” —in PC terminology.

During recording, the files and folders can be arranged in a way similar to arranging files and folders of computer data.

“Root” is similar to the root of a tree. Every file and folder can be linked to and be accessed from the root.

The illustration below shows an example of how MP3 files are recorded on a CD-R or CD-RW, how they are played back, and how they are searched for on this unit.

### Notes:

- This unit can read a CD-ROM containing MP3 files. However, if non-MP3 files are recorded together with MP3 files, this unit will take a longer time to scan the disc. It may also cause the unit to malfunction.
- This unit cannot read or play an MP3 file without the extension code <.mp3>.
- This unit is not compatible with MP3 file encoded with Layer 1 and Layer 2 formats.
- This unit is not compatible with Playlist\*\*.

\*\* A playlist is a simple text file, used on a PC, which enables users to make their own playback order without physically rearranging the files.

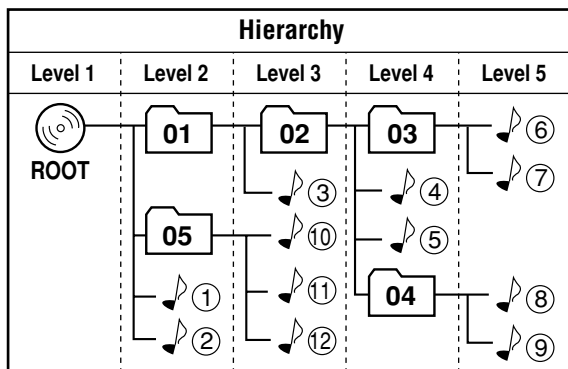

01 : Folder and their playback order

① : MP3 files and their playback order

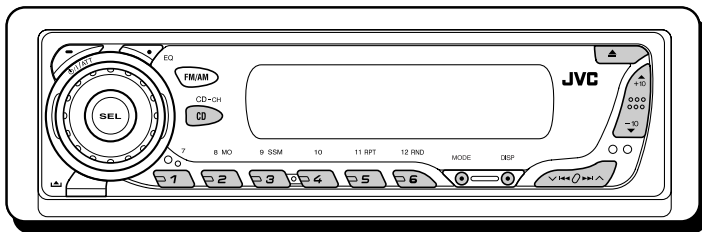

Refer also to “CD OPERATIONS” on pages 13 to 16.

The display changes to show the following:

## Playing an MP3 disc

**1** Open the control panel.

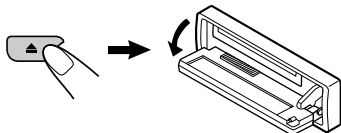

**Note on One-Touch Operation:**

When a disc is already in the loading slot, pressing CD CD-CH turns on the unit and starts playback automatically.

**2** Insert an MP3 disc into the loading slot.

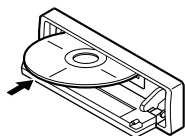

The unit turns on, draws the disc and starts playback automatically.

**3** Close the control panel by hand.

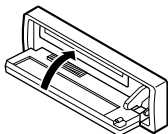

All files will be played repeatedly until you stop playback.

Current source indication

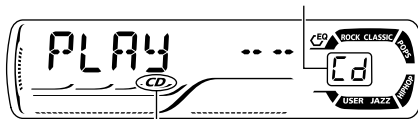

CD indicator



Total folder number

Total file number

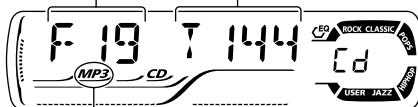

MP3 indicator

Ex.: When the disc contains 19 folders and 144 MP3 files

**Notes:**

- MP3 discs require a longer readout time. (It differs due to the complexity of the folder/file configuration.)
- When playback starts, folder and file names (or ID3 tags) will automatically appear. (See also page 19.)
- If you change the source or turn the power off, disc playback stops (without ejecting the disc). Next time you select the CD player as the source or turn the power on, disc play starts from where playback has been stopped previously.



## To stop play and eject the disc

Press ▲.

Playback stops and the control panel flips down. The disc automatically ejects from the loading slot.

## To change the display information

While playing back an MP3 file, you can change the MP3 disc information shown on the display.

DISP



Press DISP (display) repeatedly. Each time you press the button, the display changes to show the following:

- When “TAG DISP” is set to “TAG ON” (initial setting: see page 26)

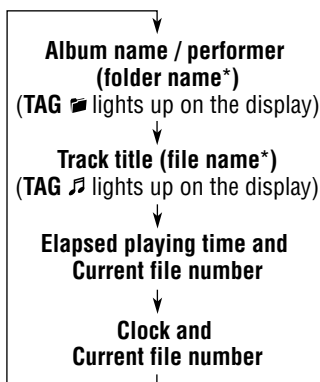

\* If an MP3 file does not have ID3 tags, folder name and file name appear. In this case, the TAG indicator will not light up on the display.

- When “TAG DISP” is set to “TAG OFF”

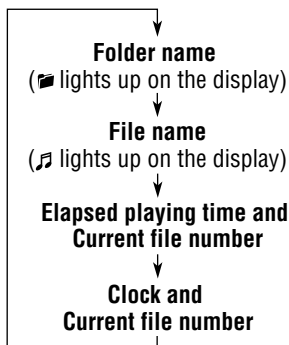

## Notes:

- The display shows up to 8 characters at a time and scrolls if there are more than 8 characters. See also “To select the scroll mode—SCROLL” on page 26.
- When folder or file name is shown, current folder number or the Tr indicator and current file number also appear on the right side of the display.

## Locating a file or a particular portion on an MP3 disc

### To fast-forward or reverse the file

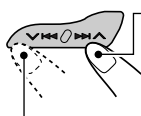

Press and hold ►►▲ while playing an MP3 disc, to fast-forward the file.

Press and hold ▼◄◄ while playing an MP3 disc, to reverse the file.

## Note:

During this operation, you can only hear intermittent sounds. (The elapsed playing time also changes intermittently on the display.)

### To skip to the next or previous files

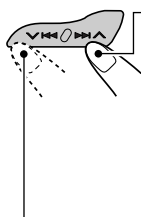

Press ►►▲ briefly while playing, to skip ahead to the beginning of the next file. Each time you press the button consecutively, the beginning of the next files is located and played back.

Press ▼◄◄ briefly while playing, to skip back to the beginning of the current file. Each time you press the button consecutively, the beginning of the previous files is located and played back.

## To go to a particular file quickly within the current folder (+10 and -10 buttons)

- 1 Press MODE to enter the functions mode while playing an MP3 disc.

MODE



- 2 Press +10 or -10.

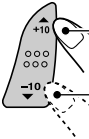

To skip 10 files\* forwards to the last file

To skip 10 files\* backwards to the first file

\* First time you press +10 or -10 button, the file skips to the nearest higher or lower file with a file number of multiple ten (ex. 10th, 20th, 30th).

Then each time you press the button, you can skip 10 files (see "How to use the +10 and -10 buttons" below).

- After the last file, the first file will be selected, and vice versa.

### How to use the +10 and -10 buttons

- Ex. 1: To select file number 32 while playing file number 6

MODE

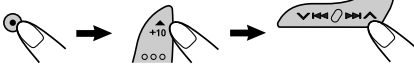

(Three times)

(Twice)

File 6 → 10 → 20 → 30 → 31 → 32

- Ex. 2: To select file number 8 while playing file number 36

MODE

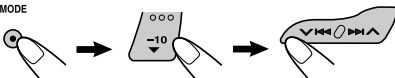

(Three times)

(Twice)

File 36 → 30 → 20 → 10 → 9 → 8

## To go to a particular folder directly

### IMPORTANT:

To directly select the folders using the number button(s), it is required that folders are assigned 2 digit numbers at the beginning of their folder names. (This can only be done during the recording of CD-Rs or CD-RWs.)

Ex.: If folder name is "01 ABC"

→ Press 1 to go to Folder 01 ABC.

If folder name is "1 ABC," pressing 1 does not work.

If folder name is "12 ABC"

→ Press and hold 6 (12) to go to Folder 12 ABC.

Press the number button corresponding to the folder number to start playing the first file in the selected folder.

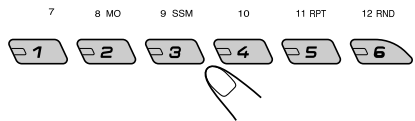

- To select a folder number from 01 – 06: Press 1 (7) – 6 (12) briefly.
- To select a folder number from 07 – 12: Press and hold 1 (7) – 6 (12) for more than one second.

### Notes:

- If indicator flashes on the display after you have selected a folder, it means that the folder does not contain any MP3 files.
- You cannot directly select a folder with a number greater than 12.

To select a particular file in a folder, press

▶▶| ^ or v |◀◀ after selecting the folder.



## To skip to the next or previous folder

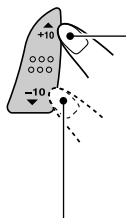

Press ▲ (up) while playing an MP3 disc to skip to the next folder. Each time you press the button consecutively, the next folder is located (and the first file in the folder starts playing, if recorded).

Press ▼ (down) while playing an MP3 disc to skip back to the previous folder. Each time you press the button consecutively, the previous folder is located (and the first file in the folder starts playing, if recorded).

### Note:

If the folder does not contain any MP3 files, it is skipped.

## Selecting MP3 playback modes

### To play back files at random (Folder Random/Disc Random Play)

You can play back all files of the current folder or all files on the MP3 disc at random.

MODE



1 Press MODE to enter the functions mode while playing an MP3 disc.

12 RND

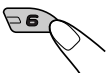

2 Press RND (random), while “MODE” is still flashing on the display, so that “FLDR RND” or “DISC RND” appears on the display. Each time you press the button, the random play mode changes as follows:

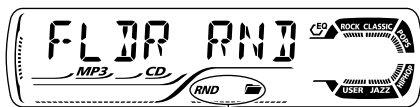

RND and (folder) indicators

Ex.: When you select “FLDR RND”

Mode	Active indicator	Plays at random
FLDR RND	RND and  indicators light up.	All files of the current folder, then files of the next folder and so on.
DISC RND	RND and  indicators light up.	All files on the disc.

### To play back files repeatedly (Track Repeat/Folder Repeat Play)

You can play back the current file or all the files in the current folder repeatedly.

MODE



1 Press MODE to enter the functions mode while playing an MP3 disc.

11 RPT

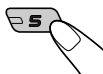

2 Press RPT (repeat), while “MODE” is still flashing on the display, so that “TRK RPT” or “FLDR RPT” appears on the display.

Each time you press the button, the repeat play mode changes as follows:

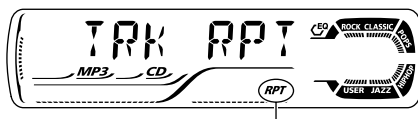

RPT indicator

Ex.: When you select “TRK RPT”

Mode	Active indicator	Plays repeatedly
TRK RPT	RPT indicator lights up.	The current (or specified) file.
FLDR RPT	and RPT indicators light up.	All files of the current (or specified) folder.



# SOUND ADJUSTMENTS

## Selecting preset sound modes (C-EQ: custom equalizer)

You can select a preset sound mode (C-EQ: custom equalizer) suitable to the music genre.

### Select the sound mode you want.



Each time you press the button, the sound modes change as follows:

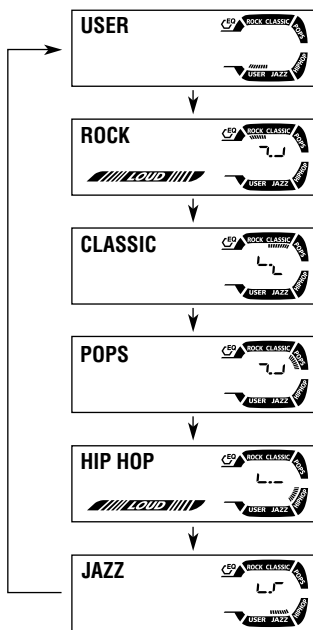

Indication pattern changes for each sound mode except for "USER."



Ex.: When you select "ROCK"

Indication	For:	Preset values		
		BAS	TRE	LOUD
USER	(Flat sound)	00	00	OFF
ROCK	Rock or disco music	+03	+01	ON
CLASSIC	Classical music	+01	-02	OFF
POPS	Light music	+04	+01	OFF
HIP HOP	Funk or rap music	+02	00	ON
JAZZ	Jazz music	+02	+03	OFF

### Note:

You can adjust each sound mode to your preference. Once you make an adjustment, it is automatically stored for the currently selected sound mode. See "Adjusting the sound" on page 23.

## Adjusting the sound

You can adjust the sound characteristics to your preference.

### 1 Select the item you want to adjust.



Each time you press the button, the adjustable items change as follows:

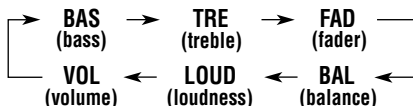

### 2 Adjust the setting.

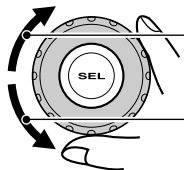

To increase the level or turn on the loudness

To decrease the level or turn off the loudness

Indication pattern changes as you adjust the bass or treble.

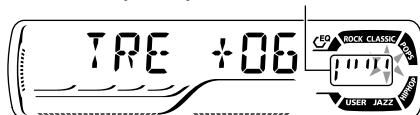

Ex. 1: When you adjust "TRE" (treble)



Ex. 2: When you turn on the loudness

### 3 Repeat steps 1 and 2 to adjust the other items.

**To reset each sound mode to the factory settings**, repeat the same procedure and reassign the preset values listed in the table on page 22.

Indication	To do:	Range
BAS* <sup>1</sup>	Adjust the bass.	-06 (min.)   +06 (max.)
TRE* <sup>1</sup>	Adjust the treble.	-06 (min.)   +06 (max.)
FAD* <sup>2</sup>	Adjust the front and rear speaker balance.	R06 (Rear only)   F06 (Front only)
BAL	Adjust the left and right speaker balance.	L06 (Left only)   R06 (Right only)
LOUD* <sup>1</sup>	Boost low and high frequencies to produce a well-balanced sound at low volume level.	LOUD ON   LOUD OFF
VOL* <sup>3</sup>	Adjust the volume.	00 (min.)   30 or 50 (max.)* <sup>4</sup>

\*<sup>1</sup> When you adjust the bass, treble, or loudness, the adjustment you have made is stored for the currently selected sound mode (C-EQ) including "USER."

\*<sup>2</sup> If you are using a two-speaker system, set the fader level to "00."

\*<sup>3</sup> Normally the control dial works as the volume control. So you do not have to select "VOL" to adjust the volume level.

\*<sup>4</sup> Depending on the amplifier gain control setting. (See page 26 for details.)



# OTHER MAIN FUNCTIONS

ENGLISH

## Changing the general settings (PSM)

You can change the items listed in the table on page 25 by using the PSM (Preferred Setting Mode) control.

### Basic Procedure

**1** Press and hold SEL (select) for more than 2 seconds so that one of the PSM items appears on the display. (See page 25.)



**2** Select the PSM item you want to adjust.

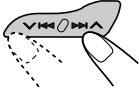

Ex.: When you select "DIMMER"

**3** Adjust the PSM item selected.

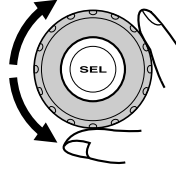

**4** Repeat steps 2 and 3 to adjust the other PSM items if necessary.

**5** Finish the setting.







### Preferred Setting Mode (PSM) items

• For detailed operations of each PSM items, refer to the pages listed in the table.

Indications		Selectable values/items		Factory-preset settings	See page
<b>DEMO</b>	Display demonstration	DEMO OFF	DEMO ON	DEMO ON	8
<b>CLOCK H</b>	Hour adjustment	1 – 12		1 (1:00)	9
<b>CLOCK M</b>	Minute adjustment	00 – 59		00 (1:00)	9
<b>LEVEL</b>	Level display	OFF	ON	ON	25
<b>DIMMER</b>	Dimmer mode	AUTO ↕ ↻	↔ ON	OFF ↕	AUTO 25
<b>SCROLL</b>	Scroll mode	ONCE ↕	↔ OFF	AUTO ↕	ONCE 26
<b>EXT IN*</b>	External component	CHANGER ↕	↔ SIRIUS	LINE IN ↕	CHANGER 26
<b>TAG DISP</b>	Tag display	TAG OFF	TAG ON	TAG ON	26
<b>AMP GAIN</b>	Amplifier gain control	LOW PWR	HIGH PWR	HIGH PWR	26

\* Displayed only when one of the following sources is selected—FM, AM, and CD.

#### To select the level meter—LEVEL

You can activate or deactivate the level meter according to your preference.

When shipped from the factory, level meter is activated.

- ON: Shows the audio level indicator.
- OFF: Cancels the audio level indicator; sound mode indicator is shown.

#### To select the dimmer mode—DIMMER

When you turn on the car headlights, the display automatically dims (Auto Dimmer).

When shipped from the factory, Auto Dimmer mode is activated.

- AUTO: Activates Auto Dimmer.
- OFF: Cancels Auto Dimmer.
- ON: Always dims the display.

**Note:**

*Auto Dimmer equipped for this unit may not work correctly on some vehicles, particularly on those having a control dial for dimming.*

*In this case, set the dimmer mode to “ON” or “OFF.”*



## To select the scroll mode—SCROLL

You can select the scroll mode for the disc information (when the entire text cannot be shown at once).

When shipped from the factory, scroll mode is set to “ONCE.”

- ONCE: Scrolls only once.
- AUTO: Repeats the scroll (5-second intervals in between).
- OFF: Cancels scroll mode.

### **Note:**

*Even if the scroll mode is set to “OFF,” you can scroll the display by pressing DISP (display) for more than one second.*

## To select the external component to use—EXT IN

You can connect the external component to the CD changer jack on the rear using an adapter specially designed for the external component. To use the external component as the playback source through this unit, you need to select which component—CD changer or external component—to use.

When shipped from the factory, CD changer is selected as the external component.

- CHANGER: To use the CD changer.
- LINE IN: To use the external component other than CD changer.
- SIRIUS: To use the JVC SIRIUS Radio.

### **Notes:**

- For connecting the Line Input Adapter KS-U57 and the external component, refer to the *Installation/Connection Manual (separate volume)*.
- For connecting the JVC SIRIUS Radio, refer to the *SIRIUS Radio Setup Manual (separate volume)*.

## To turn the tag display on or off—TAG DISP

An MP3 file can contain file information called “ID3 Tag” where its album name, performer, track title, etc. are recorded.

There are two versions—ID3v1 (ID3 Tag version 1) and ID3v2 (ID3 Tag version 2). If both ID3v1 and ID3v2 are recorded on a disc, ID3v2 information will be shown.

When shipped from the factory, “TAG ON” is selected.

- TAG ON: Turns on the ID3 tag display while playing MP3 files.
  - If an MP3 file does not have ID3 tags, folder name and file name appear.
- TAG OFF: Turns off the ID3 tag display while playing MP3 files. (Only the folder name and file name can be shown.)

## To select the amplifier gain control—AMP GAIN

You can change the maximum volume level of this unit. When the maximum power of the speakers is less than 50 W, select “LOW PWR” to prevent them from being damaged.

When shipped from the factory, “HIGH PWR” is selected.

- LOW PWR: You can adjust the volume level from “VOL 00” to “VOL 30.”

### **Note:**

*If you change the setting from “HIGH PWR” to “LOW PWR” while listening at a volume level more than 30, the unit automatically changes the volume level to “VOL 30.”*

- HIGH PWR: You can adjust the volume level from “VOL 00” to “VOL 50.”



## Detaching the control panel

You can detach the control panel when leaving the car.

When detaching or attaching the control panel, be careful not to damage the connectors on the back of the control panel and on the panel holder.

### Detaching the control panel

Before detaching the control panel, be sure to turn off the power.

- 1 **Unlock the control panel.**

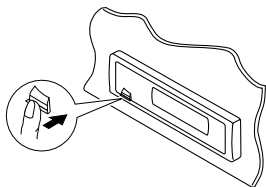

- 2 **Pull the control panel out of the unit.**

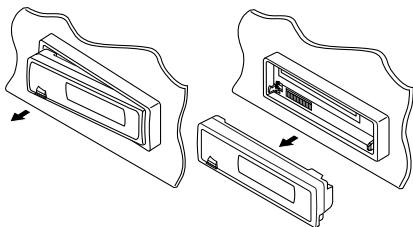

- 3 **Put the detached control panel into the provided case.**

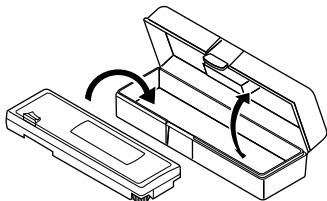

## Attaching the control panel

- 1 **Insert the right side of the control panel into the groove on the panel holder.**

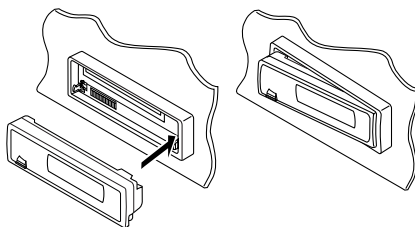

- 2 **Press the left side of the control panel to fix it to the panel holder.**

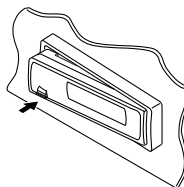

### **Note on cleaning the connectors:**

*If you frequently detach the control panel, the connectors will deteriorate.*

*To minimize this possibility, periodically wipe the connectors with a cotton swab or cloth moistened with alcohol, being careful not to damage the connectors.*

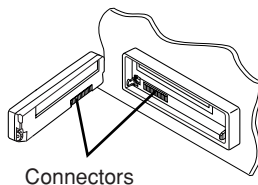

# CD CHANGER OPERATIONS

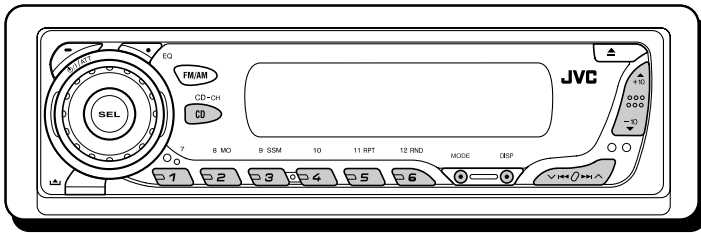

We recommend that you use the JVC MP3-compatible CD changer with your unit.

By using this CD changer, you can play back your original CD-Rs (Recordable) and CD-RWs (Rewritable) recorded either in audio CD format or in MP3 format.

- You can also connect other CH-X series CD changers (except CH-X99 and CH-X100). However, they are not compatible with MP3 discs, so you cannot play back MP3 discs.
- You cannot use the KD-MK series CD changers with this unit.

Before operating your CD changer:

- Refer also to the Instructions supplied for your CD changer.
- If no discs are in the magazine of the CD changer or the discs are inserted upside down, "NO DISC" will appear on the display. If this happens, remove the magazine and set the discs correctly.
- If no magazine is loaded in the CD changer, "NO MAG" appears on the display. If this happens, insert the magazine in the CD changer.
- If "RESET 1" – "RESET 8" appears on the display, something is wrong with the connection between this unit and the CD changer. If this happens, check the connection and make sure the cords are connected firmly. Then, press the reset button of the CD changer.

## Playing discs

### Select the CD changer (CD-CH).

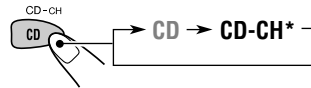

\* If you have changed "EXT IN" setting to "LINE IN" or "SIRIUS" (see page 26), you cannot select the CD changer.

### When the current disc is an MP3 disc:

Playback starts from the first folder of the current disc once file check is completed.



Selected disc number



(folder) indicator

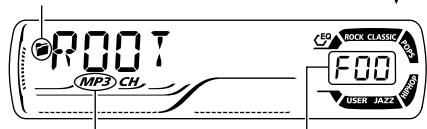

MP3 indicator

Selected folder number

### Note:

Folder name appears on the display instead of "ROOT," if an MP3 disc contains a folder.

### • When the current disc is a CD:

Playback starts from the first track of the current disc.

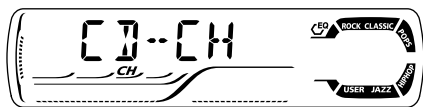

Selected disc number ↓



Elapsed playing time      Current track number ↓

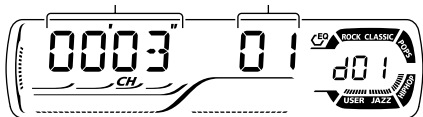

### Notes:

- When you press CD CD-CH, the power automatically comes on. You do not have to press **⏻/II/ATT** to turn on the power.
- If you change the source, CD changer play also stops. Next time you select the CD changer as the source, CD changer play starts from where playback has been stopped previously.
- When you start playing back a CD Text or MP3 disc, disc information will automatically appear on the display. (See pages 16 and 19.)

### To go to a particular disc directly

Press the number button corresponding to the disc number to start its playback (while the CD changer is playing).

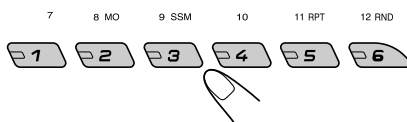

- To select a disc number from 1 – 6: Press 1 (7) – 6 (12) briefly.
- To select a disc number from 7 – 12: Press and hold 1 (7) – 6 (12) for more than one second.

### To fast-forward or reverse the track/file

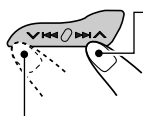

Press and hold **▶▶ ▲**, during play, to fast-forward the track/file.

Press and hold **◀◀ ▼**, during play, to reverse the track/file.

### Note:

During this operation, you can only hear intermittent sounds. (The elapsed playing time also changes intermittently on the display.)

### To skip to the next or previous tracks/files

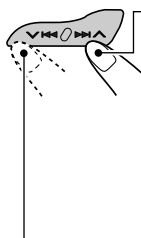

Press **▶▶ ▲** briefly during play, to skip ahead to the beginning of the next track/file. Each time you press the button consecutively, the beginning of the next tracks/files is located and played back.

Press **◀◀ ▼** briefly during play, to skip back to the beginning of the current track/file. Each time you press the button consecutively, the beginning of the previous tracks/files is located and played back.

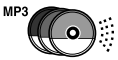

This operation is only possible when using JVC MP3-compatible CD changer (CH-X1500).

### To go to a track/file quickly (+10 and -10 buttons)

1 Press MODE to enter the functions mode while playing a disc.



2 Press +10 or -10.

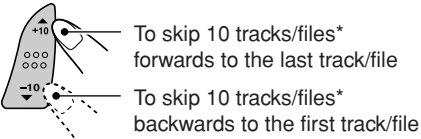

\* First time you press +10 or -10 button, the track/file skips to the nearest higher or lower track/file with a track/file number of multiple ten (ex. 10th, 20th, 30th).

Then each time you press the button, you can skip 10 tracks/files (see "How to use the +10 and -10 buttons" below).

- After the last track/file, the first track/file will be selected, and vice versa.

**Note:**  
If the current playing disc is an MP3 disc, files are skipped within the same folder.

**How to use the +10 and -10 buttons**

- Ex. 1: To select track/file number 32 while playing track/file number 6

MODE → (Three times) +10 → (Twice) +10

Track/file 6 → 10 → 20 → 30 → 31 → 32

- Ex. 2: To select track/file number 8 while playing track/file number 36

MODE → (Three times) -10 → (Twice) -10

Track/file 36 → 30 → 20 → 10 → 9 → 8

### To skip to the next or previous folder (only for MP3 discs)

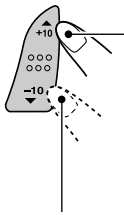

Press ▲ (up) while playing an MP3 disc, to go to the next folder. Each time you press the button consecutively, the next folder is located, and the first file in the folder starts playback.

Press ▼ (down) while playing an MP3 disc, to go to the previous folder. Each time you press the button consecutively, the previous folder is located, and the first file in the folder starts playback.

### To show the disc information for CD Text and MP3 discs

This is possible only when connecting a JVC CD changer equipped with CD Text and/or MP3 disc information reading capability.

### Select text display mode while playing a CD Text or an MP3 disc.



- For details, see page 16 about CD Text disc information and page 19 about MP3 disc information.

# Selecting the playback modes

## To play back tracks/files at random (Folder Random/Disc Random/Magazine Random Play)

**MODE**

1 Press MODE to enter the functions mode during play.

**12 RND**

2 Press RND (random), while "MODE" is still flashing on the display. Each time you press the button, the random play mode changes as follows:

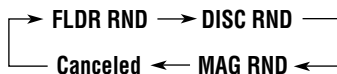
**For MP3 discs:**

**For CDs:**

**RND indicator**

Ex.: When you select "MAG RND"

**Note:**

MP3 indicator also lights up if the current playing disc is an MP3 disc.

Mode	Active indicator	Plays at random
FLDR RND*	RND and  indicators light up.	All files of the current folder, then files of the next folder and so on.
DISC RND	RND and  indicators light up.	All tracks/files of the current (or specified) disc.
MAG RND	RND indicator lights up.	All tracks/files of the inserted discs.

\* "FLDR RND" is only applicable for MP3 discs.

## To play back tracks/files repeatedly (Track Repeat/Folder Repeat/Disc Repeat Play)

**MODE**

1 Press MODE to enter the functions mode during play.

**11 RPT**

2 Press RPT (repeat), while "MODE" is still flashing on the display. Each time you press the button, the repeat play mode changes as follows:

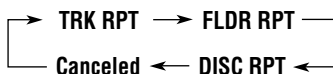
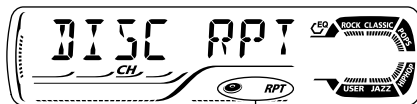
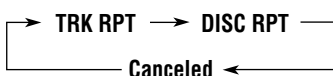
**For MP3 discs:**

**For CDs:**

(disc) and RPT indicators

Ex.: When you select "DISC RPT"

**Note:**

MP3 indicator also lights up if the current playing disc is an MP3 disc.

Mode	Active indicator	Plays repeatedly
TRK RPT	RPT indicator lights up.	The current (or specified) track/file.
FLDR RPT*	and RPT indicators light up.	All files of the current (or specified) folder of the current disc.
DISC RPT	and RPT indicators light up.	All tracks/files of the current (or specified) disc.

\* "FLDR RPT" is only applicable for MP3 discs.



# EXTERNAL COMPONENT OPERATIONS

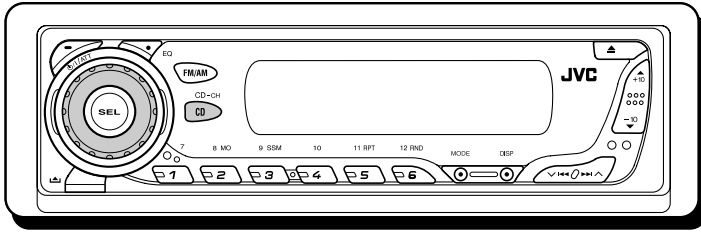

## Playing an external component

You can connect the external component to the CD changer jack on the rear using the Line Input Adapter KS-U57 (not supplied).

### Preparations:

- For connecting the Line Input Adapter KS-U57 and the external component, refer to the Installation/Connection Manual (separate volume).
- Before operating the external component using the following procedure, select the external input correctly. See “To select the external component to use—EXT IN” on page 26.

### 1 Select the external component (LINE IN).



- If “LINE IN”<sup>\*</sup> does not appear on the display, see page 26 and select the external input (“LINE IN”).

<sup>\*</sup> Displayed only when one of the following sources is selected—FM, AM, and CD.

### Note on One-Touch Operation:

When you press CD CD-CH, the power automatically comes on. You do not have to press /ATT to turn on the power.

### 2 Turn on the connected component and start playing the source.

### 3 Adjust the volume.

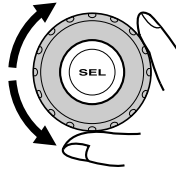

### 4 Adjust the sound as you want. (See pages 22 and 23.)

To use the JVC SIRIUS Radio, refer to the SIRIUS Radio Setup Manual (separate volume).



# TROUBLESHOOTING

What appears to be trouble is not always serious. Check the following points before calling a service center.

	Symptoms	Causes	Remedies
General	<ul style="list-style-type: none"> <li>• Sound cannot be heard from the speakers.</li> </ul>	The volume level is set to the minimum level.	Adjust it to the optimum level.
		Connections are incorrect.	Check the cords and connections.
	<ul style="list-style-type: none"> <li>• This unit does not work at all.</li> </ul>	The built-in microcomputer may have functioned incorrectly due to noise, etc.	Press the reset button on the panel holder after detaching the control panel. (The clock setting and preset stations stored in memory are erased.) (See page 2.)
FM/AM	<ul style="list-style-type: none"> <li>• SSM (Strong-station Sequential Memory) automatic preset does not work.</li> </ul>	Signals are too weak.	Store stations manually.
	<ul style="list-style-type: none"> <li>• Static noise while listening to the radio.</li> </ul>	The antenna is not connected firmly.	Connect the antenna firmly.
Disc Playback	<ul style="list-style-type: none"> <li>• Disc cannot be played back.</li> </ul>	Disc is inserted upside down.	Insert the disc correctly.
	<ul style="list-style-type: none"> <li>• CD-R/CD-RW cannot be played back.</li> <li>• Tracks on the CD-R/CD-RW cannot be skipped.</li> </ul>	CD-R/CD-RW is not finalized.	<ul style="list-style-type: none"> <li>• Insert a finalized CD-R/CD-RW.</li> <li>• Finalize the CD-R/CD-RW with the component which you used for recording.</li> </ul>
		Disc cannot be ejected.	Disc is locked.
	<ul style="list-style-type: none"> <li>• Disc sound is sometimes interrupted.</li> </ul>	You are driving on rough roads.	Stop playback while driving on rough roads.
		Disc is scratched.	Change the disc.
		Connections are incorrect.	Check the cords and connections.
<ul style="list-style-type: none"> <li>• "NO DISC" appears on the display.</li> </ul>	No disc in the loading slot.	Insert a disc into the loading slot.	
	Disc is inserted incorrectly.	Insert the disc correctly.	



	Symptoms	Causes	Remedies
MP3 Playback	<ul style="list-style-type: none"> <li>Disc cannot be played back.</li> </ul>	No MP3 files are recorded on the disc.	Change the disc.
		MP3 files do not have the extension code <.mp3> in their file names.	Add the extension code <.mp3> to their file names.
		MP3 files are not recorded in the format compliant with ISO 9660 Level 1, Level 2, Romeo, or Joliet.	Change the disc. (Record MP3 files using a compliant application.)
	<ul style="list-style-type: none"> <li>Noise is generated.</li> </ul>	The file played back is not an MP3 file (although it has the extension code <.mp3>).	Skip to another file or change the disc. (Do not add the extension code <.mp3> to non-MP3 files.)
	<ul style="list-style-type: none"> <li>A longer readout time is required ("CHECK" keeps flashing on the display).</li> </ul>	Readout time varies due to the complexity of the folder/file configuration.	Do not use too many hierarchies and folders. Also, do not record any other types of audio tracks together with MP3 files.
	<ul style="list-style-type: none"> <li>Files cannot be played back as you have intended them to play.</li> </ul>	Playback order is determined when the files are recorded.	_____
	<ul style="list-style-type: none"> <li>Elapsed playing time is not correct.</li> </ul>	This sometimes occurs during play. This is caused by how the files are recorded on the disc.	_____
	<ul style="list-style-type: none"> <li> indicator flashes on the display.</li> </ul>	The current folder does not contain any MP3 file.	Select another folder.
<ul style="list-style-type: none"> <li>"NO FILES" appears on the display.</li> </ul>	The current disc does not contain any MP3 file.	Insert a disc that contains MP3 files.	



Symptoms	Causes	Remedies
<ul style="list-style-type: none"> <li>• “NO DISC” appears on the display.</li> </ul>	No disc is in the magazine.	Insert discs into the magazine.
	Discs are inserted upside down.	Insert discs correctly.
<ul style="list-style-type: none"> <li>• “NO MAG” appears on the display.</li> </ul>	No magazine is loaded in the CD changer.	Insert the magazine.
<ul style="list-style-type: none"> <li>• “RESET 8” appears on the display.</li> </ul>	This unit is not connected to the CD changer correctly.	Connect this unit and the CD changer correctly and press the reset button of the CD changer.
<ul style="list-style-type: none"> <li>• “RESET 1” – “RESET 7” appears on the display.</li> </ul>	_____	Press the reset button of the CD changer.
<ul style="list-style-type: none"> <li>• The CD changer does not work at all.</li> </ul>	The built-in microcomputer may function incorrectly due to noise, etc.	Press the reset button on the panel holder after detaching the control panel. (The clock setting and preset stations stored in memory are erased.) (See page 2.)

CD Changer

**About mistracking:**

*Mistracking may result from driving on extremely rough roads. This does not damage the unit and the disc, but will be annoying.*

*We recommend that you stop disc play while driving on such rough roads.*



## Handling discs

This unit has been designed to reproduce CDs, CD-Rs (Recordable), CD-RWs (Rewritable), and CD Texts.

- This unit is also compatible with MP3 discs.

### How to handle discs

**When removing a disc from its case**, press down the center holder of the case and lift the disc out, holding it by the edges.

Center holder



- Always hold the disc by the edges. Do not touch its recording surface.

**When storing a disc into its case**, gently insert the disc around the center holder (with the printed surface facing up).

- Make sure to store discs into the cases after use.

### To keep discs clean

A dirty disc may not be played correctly. If a disc does become dirty, wipe it with a soft cloth in a straight line from center to edge.



### To play new discs

New discs may have some rough spots around the inner and outer edges. If such a disc is used, this unit may reject the disc.



To remove these rough spots, rub the edges with a pencil or ball-point pen, etc.

### Moisture condensation

Moisture may condense on the lens inside the CD player in the following cases:

- After starting the heater in the car.
- If it becomes very humid inside the car.

Should this occur, the CD player may malfunction. In this case, eject the disc and leave the unit turned on for a few hours until the moisture evaporates.

### When playing a CD-R or CD-RW

Before playing back CD-Rs or CD-RWs, read their instructions or cautions carefully.

- Use only “finalized” CD-Rs or CD-RWs.
- Some CD-Rs or CD-RWs may not be played back on this unit because of their disc characteristics, and for the following reasons:
  - Discs are dirty or scratched.
  - Moisture condensation on the lens inside the unit.
  - The pickup lens inside the unit is dirty.
- CD-RWs may require a longer readout time since the reflectance of CD-RWs is lower than that of regular CDs.
- CD-Rs or CD-RWs are susceptible to high temperatures or high humidity, so do not leave them inside your car.
- Do not use following CD-Rs or CD-RWs:
  - Discs with stickers, labels, or protective seal stuck to the surface.
  - Discs on which labels can be directly printed by an ink jet printer.

Using these discs under high temperatures or high humidity may cause malfunctions or damage to discs. For example,

- Stickers or labels may shrink and warp a disc.
- Stickers or labels may be peeled off so discs cannot be ejected.
- Print on discs may get sticky.

Read instructions or cautions about labels and printable discs carefully.

#### CAUTIONS:

- Do not insert 8 cm (3-3/16") discs (single CDs) into the loading slot. (Such discs cannot be ejected.)
- Do not insert any disc of unusual shape—like a heart or flower; otherwise, it will cause a malfunction.
- Do not expose discs to direct sunlight or any heat source or place them in a place subject to high temperature and humidity. Do not leave them in a car.
- Do not use any solvent (for example, conventional record cleaner, spray, thinner, benzine, etc.) to clean discs.

Warped disc



Sticker



Sticker residue

Disc



Stick-on label

## AUDIO AMPLIFIER SECTION

Maximum Power Output:

Front: 50 W per channel

Rear: 50 W per channel

Continuous Power Output (RMS):

Front: 19 W per channel into 4  $\Omega$ , 40 Hz to 20 000 Hz at no more than 0.8% total harmonic distortion.

Rear: 19 W per channel into 4  $\Omega$ , 40 Hz to 20 000 Hz at no more than 0.8% total harmonic distortion.

Load Impedance: 4  $\Omega$  (4  $\Omega$  to 8  $\Omega$  allowance)

Tone Control Range

Bass:  $\pm 10$  dB at 100 Hz

Treble:  $\pm 10$  dB at 10 kHz

Frequency Response: 40 Hz to 20 000 Hz

Signal-to-Noise Ratio: 70 dB

Line-Out Level/Impedance:

2.5 V/20 k $\Omega$  load (full scale)

Output Impedance: 1 k $\Omega$

## TUNER SECTION

Frequency Range

FM: 87.5 MHz to 107.9 MHz

AM: 530 kHz to 1 710 kHz

### **[FM Tuner]**

Usable Sensitivity: 11.3 dBf (1.0  $\mu$ V/75  $\Omega$ )

50 dB Quieting Sensitivity:

16.3 dBf (1.8  $\mu$ V/75  $\Omega$ )

Alternate Channel Selectivity (400 kHz):

65 dB

Frequency Response: 40 Hz to 15 000 Hz

Stereo Separation: 35 dB

Capture Ratio: 1.5 dB

### **[AM Tuner]**

Sensitivity: 20  $\mu$ V

Selectivity: 35 dB

## CD PLAYER SECTION

Type: Compact disc player

Signal Detection System: Non-contact optical pickup (semiconductor laser)

Number of channels: 2 channels (stereo)

Frequency Response: 5 Hz to 20 000 Hz

Dynamic Range: 96 dB

Signal-to-Noise Ratio: 98 dB

Wow and Flutter: Less than measurable limit

MP3 decoding format:

MPEG1/2 Audio Layer 3

Max. Bit Rate: 320 Kbps

## GENERAL

Power Requirement

Operating Voltage:

DC 14.4 V (11 V to 16 V allowance)

Grounding System: Negative ground

Allowable Operating Temperature:

0°C to +40°C (32°F to 104°F)

Dimensions (W  $\times$  H  $\times$  D):

Installation Size (approx.):

182 mm  $\times$  52 mm  $\times$  150 mm

(7-3/16"  $\times$  2-1/16"  $\times$  5-15/16")

Panel Size (approx.):

188 mm  $\times$  58 mm  $\times$  12 mm

(7-7/16"  $\times$  2-5/16"  $\times$  1/2")

Mass (approx.):

1.4 kg (3.1 lbs) (excluding accessories)

*Design and specifications are subject to change without notice.*

If a kit is necessary for your car, consult your telephone directory for the nearest car audio speciality shop.



**JVC**

**MOBILE**  
ENTERTAINMENT

<http://www.jvcmobile.com>

*Visit us on-line for*

*Technical Support & Customer Satisfaction Survey.*

**US RESIDENTS ONLY**

**Having TROUBLE with operation?**

**Please reset your unit**

Refer to page of How to Reset

**Still having trouble??**

**USA ONLY**

**Call 1-800-252-5722**

<http://www.jvc.com>

**We can help you!**

**JVC**

VICTOR COMPANY OF JAPAN, LIMITED



EN, SP, FR

© 2003 VICTOR COMPANY OF JAPAN, LIMITED

1003KKSMdTJEIN

### ENGLISH

### ESPAÑOL

### FRANÇAIS

This unit is designed to operate on **12 V DC, NEGATIVE ground electrical systems**. If your vehicle does not have this system, a voltage inverter is required, which can be purchased at JVC car audio dealers.

Esta unidad está diseñada para funcionar con **12 V de CC, con sistemas eléctricos de masa NEGATIVA**. Si su vehículo no posee este sistema, será necesario un inversor de tensión, que puede ser adquirido en los concesionarios de JVC de equipos de audio para automóviles.

Cet appareil est conçu pour fonctionner sur des sources de courant continu de **12 V à masse NEGATIVE**. Si votre véhicule n'offre pas ce type d'alimentation, il vous faut un convertisseur de tension, que vous pouvez acheter chez un revendeur d'autoradios JVC.

#### Parts list for installation and connection

The following parts are provided with this unit. After checking them, please set them correctly.

#### Lista de piezas para instalación y conexión

Con esta unidad se suministran las siguientes piezas. Después de inspeccionarlas, colóquelas correctamente.

#### Liste des pièces pour l'installation et raccordement

Les pièces suivantes sont fournies avec cet appareil. Après vérification, veuillez les placer correctement.

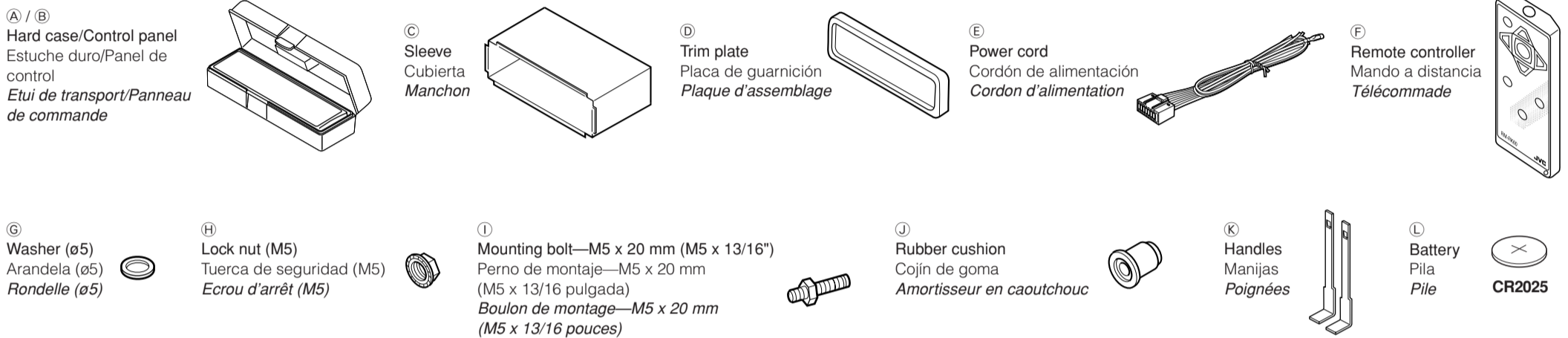

### INSTALLATION (IN-DASH MOUNTING)

### INSTALACION (MONTAJE EN EL TABLERO DE INSTRUMENTOS)

### INSTALLATION (MONTAGE DANS LE TABLEAU DE BORD)

The following illustration shows a typical installation. If you have any questions or require information regarding installation kits, consult your JVC car audio dealer or a company supplying kits.

La siguiente ilustración muestra una instalación típica. Si tiene alguna pregunta o necesita información acerca de las herramientas para instalación, consulte con su concesionario de JVC de equipos de audio para automóviles o a una compañía que suministra tales herramientas.

L'illustration suivante est un exemple d'installation typique. Si vous avez des questions ou avez besoin d'information sur des kits d'installation, consultez votre revendeur d'autoradios JVC ou une compagnie d'approvisionnement.

• If you are not sure how to install this unit correctly, have it installed by a qualified technician.

• Si usted no está seguro de cómo instalar correctamente la unidad, hágala instalar por un técnico cualificado.

• Si l'on n'est pas sûr de pouvoir installer correctement cet appareil, le faire installer par un technicien qualifié.

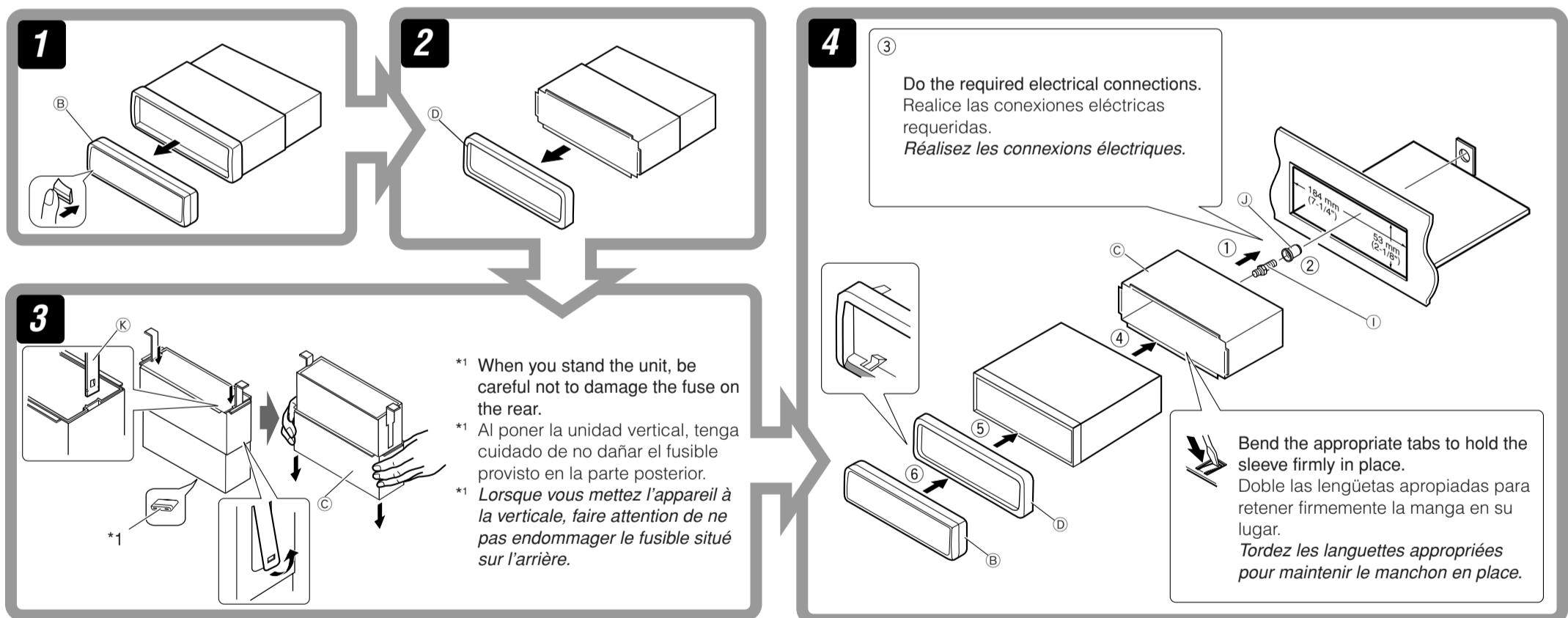

### Removing the unit

Before removing the unit, release the rear section.

### Extracción de la unidad

Antes de extraer la unidad, libere la sección trasera.

### Retrait de l'appareil

Avant de retirer l'appareil, libérer la section arrière.

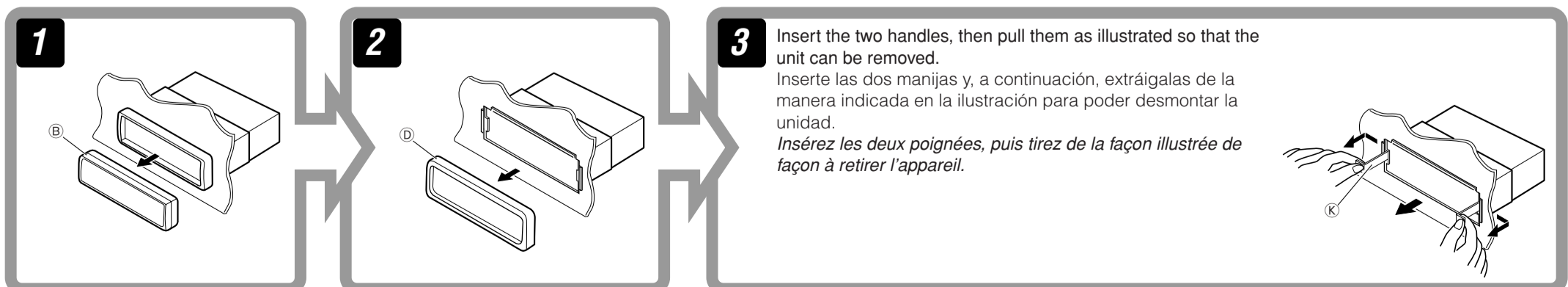

## When using the optional stay / Cuando emplea un soporte opcional / Lors de l'utilisation du hauban en option

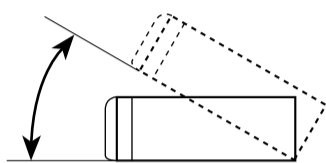
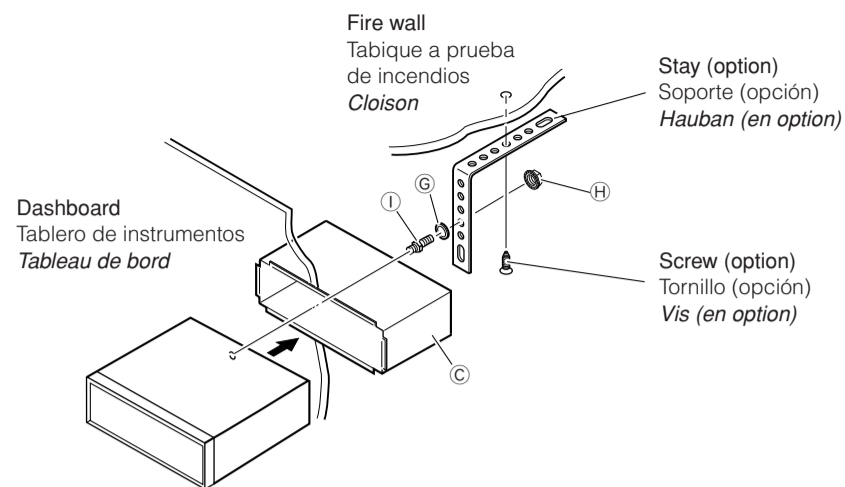

Install the unit at an angle of less than 30°.  
Instale la unidad a un ángulo de menos de 30°.  
Installez l'appareil avec un angle de moins de 30°.

## When installing the unit without using the sleeve / Instalación de la unidad sin utilizar la cubierta / Lors de l'installation de l'appareil sans utiliser de manchon

In a Toyota for example, first remove the car radio and install the unit in its place.  
En un Toyota por ejemplo, primero retire la radio del automóvil y luego instale la unidad en su lugar.  
Par exemple dans une Toyota, retirer d'abord l'autoradio et installer l'appareil à la place.

Flat type screws—M5 x 8 mm (M5 x 3/8")\*  
Tornillos tipo plano—M5 x 8 mm (M5 x 3/8 pulgada)\*  
Vis à tête plate—M5 x 8 mm (M5 x 3/8 pouces)\*

\* Not included with this unit.  
\* No suministrado con esta unidad.  
\* Non fourni avec cet appareil.

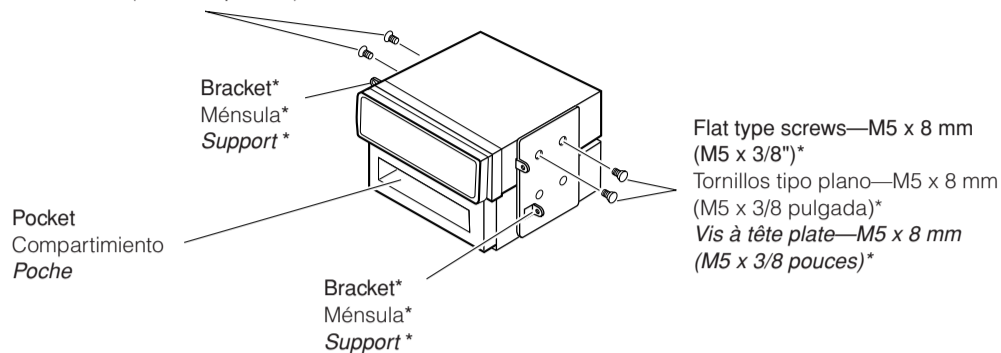

**Note** : When installing the unit on the mounting bracket, make sure to use the 8 mm (3/8") -long screws. If longer screws are used, they could damage the unit.

**Nota** : Cuando instala la unidad en la ménsula de montaje, asegúrese de utilizar los tornillos de 8 mm (3/8 pulgada) de longitud. Si se utilizan tornillos más largos, éstos pueden dañar la unidad.

**Remarque** : Lors de l'installation de l'appareil sur le support de montage, s'assurer d'utiliser des vis d'une longueur de 8 mm (3/8 pouces). Si des vis plus longues sont utilisées, elles peuvent endommager l'appareil.

## ELECTRICAL CONNECTIONS

To prevent short circuits, we recommend that you disconnect the battery's negative terminal and make all electrical connections before installing the unit.

- Be sure to ground this unit to the car's chassis again after installation.

### Notes:

- Replace the fuse with one of the specified rating. If the fuse blows frequently, consult your JVC car audio dealer.
- It is recommended to connect to the speakers with maximum power of more than 50 W (both at the rear and at the front, with an impedance of 4 Ω to 8 Ω). If the maximum power is less than 50 W, change "AMP GAIN" setting to prevent the speakers from being damaged (see page 26 of the INSTRUCTIONS).
- To prevent short-circuit, cover the terminals of the UNUSED leads with insulating tape.
- The heat sink becomes very hot after use. Be careful not to touch it when removing this unit.

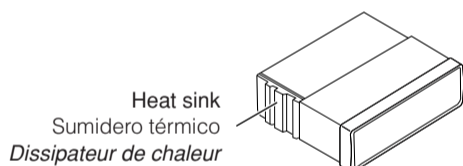

## CONEXIONES ELECTRICAS

Para evitar cortocircuitos, recomendamos que desconecte el terminal negativo de la batería y que efectúe todas las conexiones eléctricas antes de instalar la unidad.

- Asegúrese de volver a conectar a masa esta unidad al chasis del automóvil después de la instalación.

### Notas:

- Reemplace el fusible por uno con la corriente especificada. Si el fusible se quemase frecuentemente consulte con su concesionario de JVC de equipos de audio para automóviles.
- Se recomienda conectar los altavoces con una potencia máxima de más de 50 W (tanto atrás como adelante, con una impedancia de 4 Ω a 8 Ω). Si la potencia máxima es de menos de 50 W, cambie "AMP GAIN" para evitar daños en los altavoces (consulte la página 26 del MANUAL DE INSTRUCCIONES).
- Para evitar cortocircuitos, cubra los cables NO UTILIZADOS con cinta aislante.
- El sumidero térmico estará muy caliente después del uso. Asegúrese de no tocarlo al desmontar esta unidad.

## RACCORDEMENTS ELECTRIQUES

Pour éviter tout court-circuit, nous vous recommandons de débrancher la borne négative de la batterie et d'effectuer tous les raccordements électriques avant d'installer l'appareil.

- Assurez-vous de raccorder de nouveau la mise à la masse de cet appareil au châssis de la voiture après l'installation.

### Remarques:

- Remplacer le fusible par un de la valeur précisée. Si le fusible saute souvent, consulter votre revendeur d'autoradios JVC.
- Il est recommandé de connecter des enceintes avec une puissance de plus de 50 W (les enceintes arrière et les enceintes avant, avec une impédance comprise entre 4 Ω et 8 Ω). Si la puissance maximum est inférieure à 50 W, changez "AMP GAIN" pour éviter d'endommager vos enceintes (voir page 26 du MANUEL D'INSTRUCTIONS).
- Pour éviter les court-circuits, couvrir les bornes des fils qui ne sont PAS UTILISÉS avec de la bande isolante.
- Le dissipateur de chaleur devient très chaud après usage. Faire attention de ne pas le toucher en retirant cet appareil.

## PRECAUTIONS on power supply and speaker connections:

- DO NOT connect the speaker leads of the power cord to the car battery; otherwise, the unit will be seriously damaged.
- BEFORE connecting the speaker leads of the power cord to the speakers, check the speaker wiring in your car.

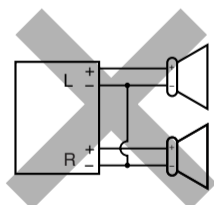

## PRECAUCIONES sobre las conexiones de la fuente de alimentación y de los altavoces:

- NO conecte los conductores de altavoz del cable de alimentación a la batería de automóvil, pues podrían producirse graves daños en la unidad.
- ANTES de conectar a los altavoces los conductores de altavoz del cable de alimentación, verifique el conexionado de altavoz de su automóvil.

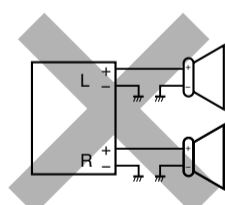

## PRECAUTIONS sur l'alimentation et la connexion des enceintes:

- NE CONNECTEZ PAS les fils d'enceintes du cordon d'alimentation à la batterie; sinon, l'appareil serait sérieusement endommagé.
- AVANT de connecter les fils d'enceintes du cordon d'alimentation aux enceintes, vérifiez le câblage des enceintes de votre voiture.

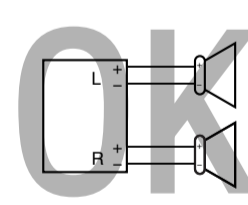

## TROUBLESHOOTING

- **The fuse blows.**
  - \* Are the red and black leads connected correctly?
- **Power cannot be turned on.**
  - \* Is the yellow lead connected?
- **No sound from the speakers.**
  - \* Is the speaker output lead short-circuited?
- **Sound is distorted.**
  - \* Is the speaker output lead grounded?
  - \* Are the "-" terminals of L and R speakers grounded in common?
- **Noise interfere with sounds.**
  - \* Is the rear ground terminal connected to the car's chassis using shorter and thicker cords?
- **Unit becomes hot.**
  - \* Is the speaker output lead grounded?
  - \* Are the "-" terminals of L and R speakers grounded in common?

## LOCALIZACION DE AVERIAS

- **El fusible se quema.**
  - \* ¿Están los conductores rojo y negro correctamente conectados?
- **No es posible conectar la alimentación.**
  - \* ¿Está el cable amarillo conectado?
- **No sale sonido de los altavoces.**
  - \* ¿Está el cable de salida del altavoz cortocircuitado?
- **El sonido presenta distorsión.**
  - \* ¿Está el cable de salida del altavoz conectado a masa?
  - \* ¿Están los terminales "-" de los altavoces L y R conectados a una masa común?
- **Perturbación de ruido.**
  - \* ¿El terminal de tierra trasero está conectado al chasis del automóvil utilizando los cordones más corto y más grueso?
- **La unidad se calienta.**
  - \* ¿Está el cable de salida del altavoz conectado a masa?
  - \* ¿Están los terminales "-" de los altavoces L y R conectados a una masa común?

## EN CAS DE DIFFICULTES

- **Le fusible saute.**
  - \* Les fils rouge et noir sont-ils raccordés correctement?
- **L'appareil ne peut pas être mise sous tension.**
  - \* Le fil jaune est-elle raccordée?
- **Pas de son des enceintes.**
  - \* Le fil de sortie d'enceinte est-il court-circuité?
- **Le son est déformé.**
  - \* Le fil de sortie d'enceinte est-il à la masse?
  - \* Les bornes "-" des enceintes gauche et droit sont-elles mises ensemble à la masse?
- **Interférence avec les sons.**
  - \* La prise arrière de mise à la terre est-elle connectée au châssis de la voiture avec un cordon court et épais?
- **L'appareil devient chaud.**
  - \* Le fil de sortie d'enceinte est-il à la masse?
  - \* Les bornes "-" des enceintes gauche et droit sont-elles mises ensemble à la masse?



**A Typical Connections / Conexiones típicas / Raccordements typiques**

**Before connecting:** Check the wiring in the vehicle carefully. Incorrect connection may cause serious damage to this unit. The leads of the power cord and those of the connector from the car body may be different in color.

- 1 Connect the colored leads of the power cord in the order specified in the illustration below.
- 2 Connect the antenna cord.
- 3 Finally connect the wiring harness to the unit.

**Antes de la conexión:** Verifique atentamente el conexionado del vehículo. Una conexión incorrecta podría producir daños graves en la unidad. Los cordones del cable de alimentación y los del conector procedentes de la carrocería del automóvil podrían ser de diferentes en color.

- 1 Conecte los conductores de color del cable de alimentación en el orden especificado en la ilustración de abajo.
- 2 Conecte el cable de antena.
- 3 Por último, conecte el cable de alimentación a la unidad.

**Avant de commencer la connexion:** Vérifiez attentivement le câblage du véhicule. Une connexion incorrecte peut endommager sérieusement l'appareil. Le fil du cordon d'alimentation et ceux des connecteurs du châssis de la voiture peuvent être différents en couleur.

- 1 Connectez les fils colorés du cordon d'alimentation dans l'ordre spécifié sur l'illustration ci-dessous.
- 2 Connectez le cordon d'antenne.
- 3 Finalement, connectez le faisceau de fils à l'appareil.

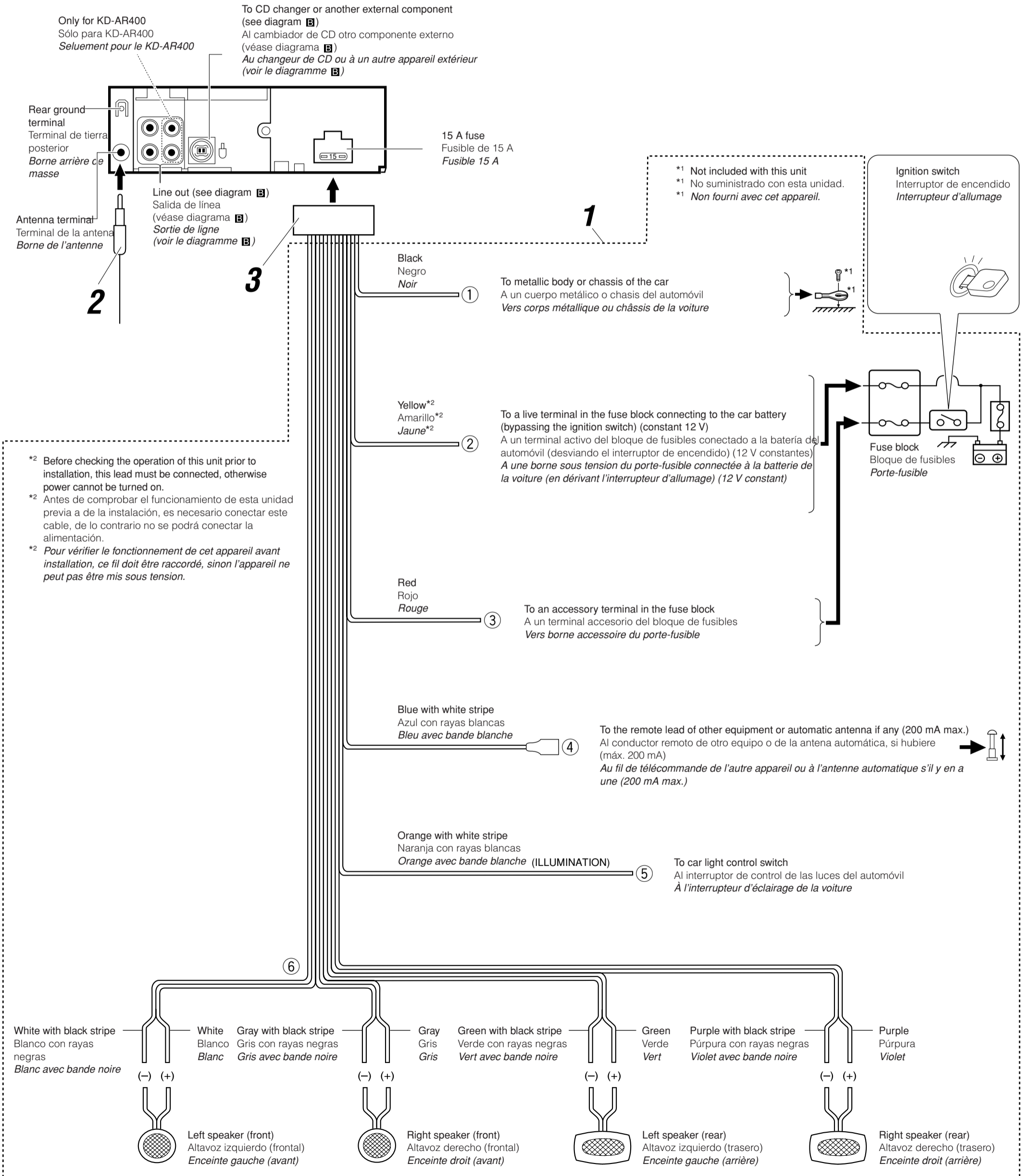

**Amplifier / Amplificador / Amplificateur**

You can connect an amplifier and other equipment to upgrade your car stereo system.

- Connect the remote lead (blue with white stripe) to the remote lead of the other equipment so that it can be controlled through this unit.
- **For amplifier only:** Disconnect the speakers from this unit, connect them to the amplifier. Leave the speaker leads of this unit unused.

Usted podrá conectar un amplificador y otros equipos para mejorar el sistema estéreo de su automóvil.

- Conecte el conductor remoto (azul con rayas blancas) al conductor remoto del otro equipo para poderlo controlar a través de esta unidad.
- **Sólo para el amplificador:** Desconecte los altavoces de esta unidad y conéctelos al amplificador. Los cables de los altavoces de esta unidad quedan sin usar.

Vous pouvez connecter un amplificateur ou autre appareil pour améliorer votre système autoradio.

- Connectez le fil de commande à distance (bleu avec bande blanche) au fil de commande à distance de l'autre appareil de façon qu'il puisse être commandé via cet appareil.
- **Pour l'amplificateur seulement:** Déconnectez les enceintes de cet appareil et connectez-les à l'amplificateur. Laissez les fils d'enceintes de cet appareil inutilisés.

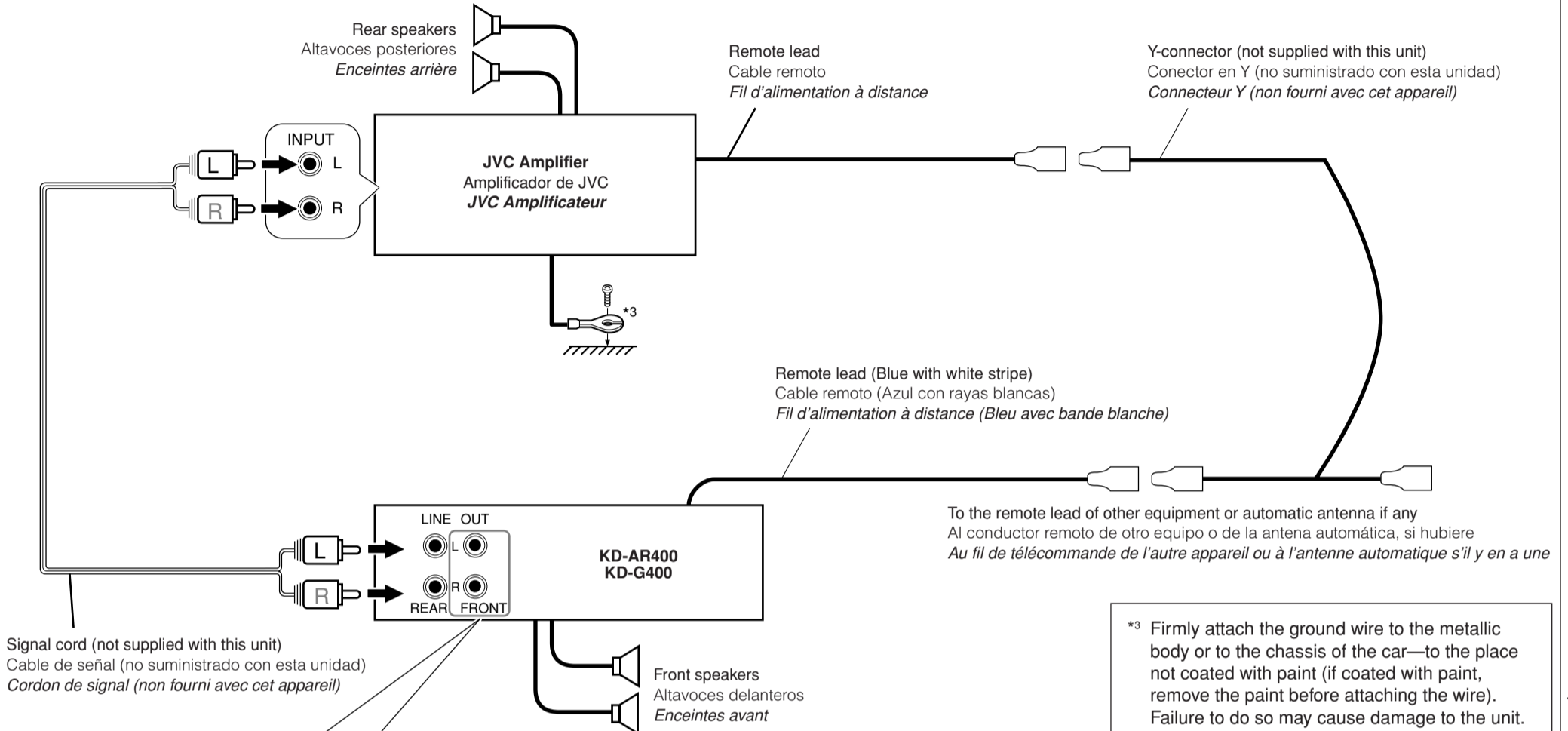

Signal cord (not supplied with this unit)  
Cable de señal (no suministrado con esta unidad)  
Cordon de signal (non fourni avec cet appareil)

Only for KD-AR400 / Sólo para KD-AR400 / Seulement pour le KD-AR400

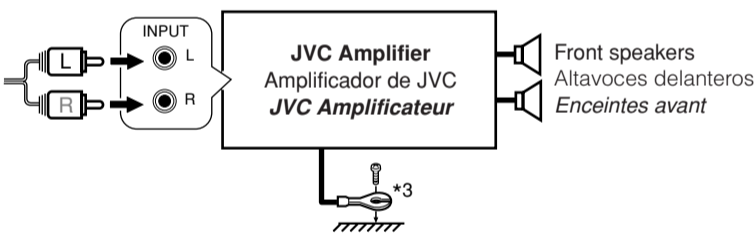

You can connect another power amplifier for front speakers.  
Podrá conectar otro amplificador de potencia para los altavoces delanteros.  
Vous pouvez connecter un autre amplificateur de puissance pour les enceintes avant.

\*3 Firmly attach the ground wire to the metallic body or to the chassis of the car—to the place not coated with paint (if coated with paint, remove the paint before attaching the wire). Failure to do so may cause damage to the unit.  
\*3 Fije firmemente el cable de tierra a la carrocería metálica o al chasis—a un lugar no cubierto con pintura (si está cubierto con pintura, quítela antes de fijar el cable). De lo contrario, se podrían producir daños en la unidad.  
\*3 Attachez solidement le fil de mise à la masse au châssis métallique de la voiture—à un endroit qui n'est pas recouvert de peinture (s'il est recouvert de peinture, enlevez d'abord la peinture avant d'attacher le fil). L'appareil peut être endommagé si cela n'est pas fait correctement.

**CD Changer / Cambiador de CD / Changeur CD**

Refer also to page 28 of the INSTRUCTIONS.  
Consulte también la página 28 de las MANUAL DE INSTRUCCIONES.  
Référez-vous aussi à la page 28 du MANUEL D'INSTRUCTIONS.

Connecting cord supplied for your CD changer  
Cable de conexión suministrado con su cambiador de CD  
Cordon de connexion fourni avec votre changeur CD

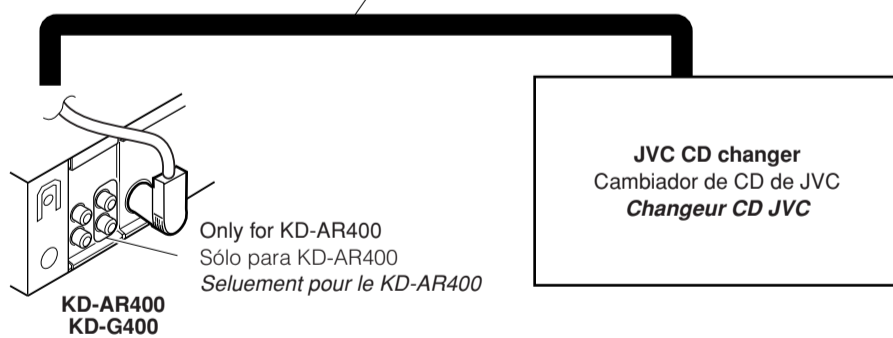

Only for KD-AR400  
Sólo para KD-AR400  
Seulement pour le KD-AR400

**CAUTION / PRECAUCION / PRECAUTION**

- Before connecting the CD changer, make sure that the unit is turned off.
- Antes de conectar el cambiador de CD, asegúrese de que la unidad esté apagada.
- Avant de connecter le changeur CD, s'assurer que l'unité est éteinte.

**External Component / Componente exterior / Appareil extérieur**

For connecting the JVC SIRIUS Radio, refer to the SIRIUS Radio Setup Manual (separate volume).  
Para la conexión de la radio JVC SIRIUS, consulte el Manual de configuración de la radio SIRIUS (volumen separado).  
Pour brancher la radio JVC SIRIUS, référez-vous au Manuel d'installation de la radio SIRIUS (volume séparé).

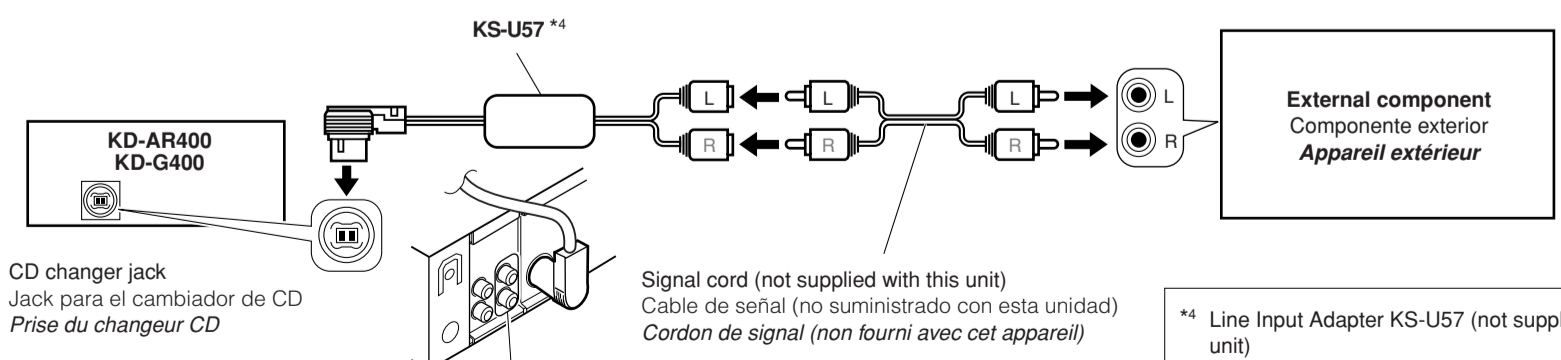

CD changer jack  
Jack para el cambiador de CD  
Prise du changeur CD

Signal cord (not supplied with this unit)  
Cable de señal (no suministrado con esta unidad)  
Cordon de signal (non fourni avec cet appareil)

Only for KD-AR400  
Sólo para KD-AR400  
Seulement pour le KD-AR400

\*4 Line Input Adapter KS-U57 (not supplied with this unit)  
\*4 Adaptador de entrada de línea KS-U57 (no suministrado con esta unidad)  
\*4 Adaptateur d'entrée de ligne KS-U57 (non fourni avec cet appareil)